



## RWF50.2 and RWF50.3

### Compact universal controllers

Optimized for temperature and pressure control in connection with modulating or multistage burners and air conditioning systems

### User Manual

The RWF50.2/RWF50.3 and this User Manual are intended for use by OEMs which integrate the controllers in their products!



**Caution!**

All safety, warning and technical notes contained in the Data Sheet on the RWF50... (N7866) also apply to this document!



# Supplementary documentation

Data Sheet RWF50.....	N7866
Environmental Declaration RWF50.....	E7866



# Contents

1	Introduction.....	8
1.1	General notes.....	8
1.2	Typographical conventions.....	9
1.2.1	Safety notes.....	9
1.2.2	Warning symbols.....	9
1.2.3	Notification symbols.....	10
1.2.4	Presentation.....	10
1.3	Description.....	11
1.4	Block structure.....	12
2	Identification of product no. ....	13
2.1	Type field.....	13
2.2	Scope of delivery.....	13
3	Installation.....	14
3.1	Installation site and climatic conditions.....	14
3.2	Dimensions.....	14
3.3	Side-by-side mounting.....	15
3.4	Mounting the controller in a panel cutout.....	15
3.5	Removing the controller from the panel cutout.....	16
3.6	Cleaning the front.....	16
4	Electrical connections.....	17
4.1	Installation notes.....	17
4.2	Galvanic separation.....	18
4.3	Assignment of terminals.....	19
5	Operating modes.....	21
5.1	Low-fire operation.....	21
5.2	High-fire operation.....	22
5.2.1	Modulating burner, 3-position output.....	22
5.2.2	Modulating burner, analog output.....	23
5.2.3	2-stage burner, 3-position output.....	24
5.2.4	2-stage burner, analog output.....	25
5.3	Burner shutdown.....	26
5.4	Predefined setpoint.....	27
5.5	Response threshold (q).....	28
5.6	Cold start of plant.....	29
5.7	Thermal shock protection (TSS).....	31
6	Operation.....	32

6.1	Meaning of display and buttons .....	32
6.2	Basic display .....	33
6.3	User level .....	34
6.4	Manual control, modulating burner .....	35
6.5	Manual control, 2-stage burner .....	36
6.6	Starting the self-setting function.....	37
6.7	Display of software version .....	38
7	Parameterization PArA.....	39
8	Configuration ConF .....	41
8.1	Analog input InP1 .....	42
8.2	Controller Cntr .....	43
8.3	Thermal shock protection (TSS) rAFC .....	44
8.4	Control outputs OutP.....	45
8.5	Binary input bi nF .....	46
8.6	Display di SP .....	47
9	Self-setting function .....	48
9.1	Self-setting function in high-fire operation.....	48
9.2	Checking the controller parameters .....	50
10	PC software ACS411 .....	51
10.1	Safety notes .....	51
10.2	Setting the correct system parameters .....	51
10.3	Changing the parameters .....	51
10.4	Place of installation .....	52
10.5	License and liability regulations .....	52
10.6	Procurement of PC software ACS411 .....	52
10.7	Languages .....	52
10.8	Operating systems : Operating .....	52
10.9	Prerequisites for hardware .....	52
10.10	Installation .....	53
10.11	Others .....	53
10.11.1	Use of USB port : Use of.....	53
10.11.2	Powering the controller via the USB port : Powering the controller via the port.....	53
11	What to do if .....	54
11.1	Alarm messages: .....	54
11.2	Others .....	54
12	Technical data.....	55
12.1	Inputs .....	55

12.1.1	Resistance thermometers.....	55
12.1.2	Input signals .....	55
12.1.3	Binary input D1 .....	55
12.2	Monitoring the measuring circuit.....	56
12.3	Controller outputs OutP Controller o.....	56
12.4	Controller .....	56
12.5	Electrical data .....	57
12.6	Housing .....	57
12.7	Environmental conditions .....	58
12.8	Segment display .....	58
12.9	Standards and certificates .....	58
13	Key .....	59
14	List of figures .....	61

# 1 Introduction

---

## 1.1 General notes



Please read this User Manual before switching on the controller. Keep the User Manual in a safe place which can be accessed by all users at all times.



Version!

This User Manual describes all necessary settings (applicable to controller software version XXX.01.01).



Reference!

See chapter 6.7 *Display of software version*.



Should any problems arise during commissioning, do not make any unauthorized manipulations on the unit. You could endanger your rights under the warranty terms! Please contact us in such a case.



## 1.2 Typographical conventions

### 1.2.1 Safety notes

This User Manual contains information which must be observed to ensure your own personal safety and to prevent damage to equipment and property. The instructions and notes are highlighted by warning triangles, a hand or arrow symbol and are presented as follows, depending on the hazard level:

#### Qualified personnel

Only **qualified personnel** are allowed to install and operate the equipment. Qualified personnel in the context of the safety-related notes contained in this document are persons who are authorized to commission, ground and tag devices, systems and electrical circuits in compliance with established safety practices and standards.

#### Correct use

Note the following:

The controller may only be used on the applications described in the technical documentation and only in connection with devices or components from other suppliers that have been approved or recommended by Siemens.

The product can only function correctly and safely if shipped, stored, set up and installed correctly, and operated and maintained as specified.

### 1.2.2 Warning symbols

The symbols for **Caution** and **Attention** are used in this User Manual under the following conditions:



#### Caution

This symbol is used where there may be a **danger to personnel** if the instructions are disregarded or not strictly observed!



#### Attention



This symbol is used where **damage to equipment or data** can occur if the instructions are disregarded or not strictly observed!



#### Attention

This symbol is used if **precautionary measures must be taken** when handling electrostatically sensitive components.

### 1.2.3 Notification symbols

	<b>Note</b>	This symbol is used to draw your <b>special attention</b> to a remark.
	<b>Reference</b>	This symbol refers to <b>additional information</b> in other documents, chapters or sections.
abc <sup>1</sup>	<b>Footnote</b>	Footnotes are <b>comments, referring to specific parts of the text</b> . They consist of 2 parts: 1) <b>Markings</b> in the text are arranged as continuous superscript numbers 2) <b>Footnote text</b> is placed at the bottom of the page and starts with a number and a period
*	<b>Action</b>	An asterisk indicates that a <b>required action</b> is described.  The individual steps are indicated by asterisks, for example:  * Press 

### 1.2.4 Presentation

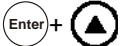
	<b>Buttons</b>	Buttons are shown in a circle. Either symbols or text are possible. If a button has multiple assignments, the text shown is always the text corresponding to the function currently used.
	<b>Button combinations</b>	Two buttons shown in combination with a plus sign means that they must be pressed simultaneously.
ConF → InP → InP1	<b>Command chain</b>	Arrows between words serve for finding parameters at the configuration level more easily or for navigating in the ACS411 setup program.

## 1.3 Description

<b>Use in heating plants</b>	The RWF50... is used primarily for the control of temperature or pressure in oil- or gas-fired heating plants. Depending on the model, it is employed as a compact 3-position controller without feedback of angular positioning or as a modulating controller with an analog output. An external switch is provided to convert it to a 2-position controller for controlling 2-stage burners. The built-in thermostat function switches the burner on and off.
<b>Cooling controller</b>	The controller's operating mode can be changed from heating to cooling, or vice versa.  ⇒ <b>Reference!</b> See chapter 8.2 <i>Controller Cntr.</i>
<b>RWF50...</b>	The controllers feature two 4-digit 7-segment displays for the actual value (red) and the setpoint (green). The RWF50.2 has a 3-position output consisting of 2 relays to open or close a controlling element. The RWF50.3 has an analog output.
<b>Control</b>	In modulating mode, the RWF50... operates as a PID controller. In 2-stage mode, the RWF50... provides control based on the set switching threshold. Using the binary input, a change to a second setpoint can be made or the setpoint can be shifted. Standard feature is a self-setting function used to determine the PID control parameters.
<b>Mounting</b>	The controller insert measures 48 x 48 x 104 mm and is especially suited for installation in control panels. All electrical connections are made via screw terminals at the rear of the unit.

## 1.4 Block structure

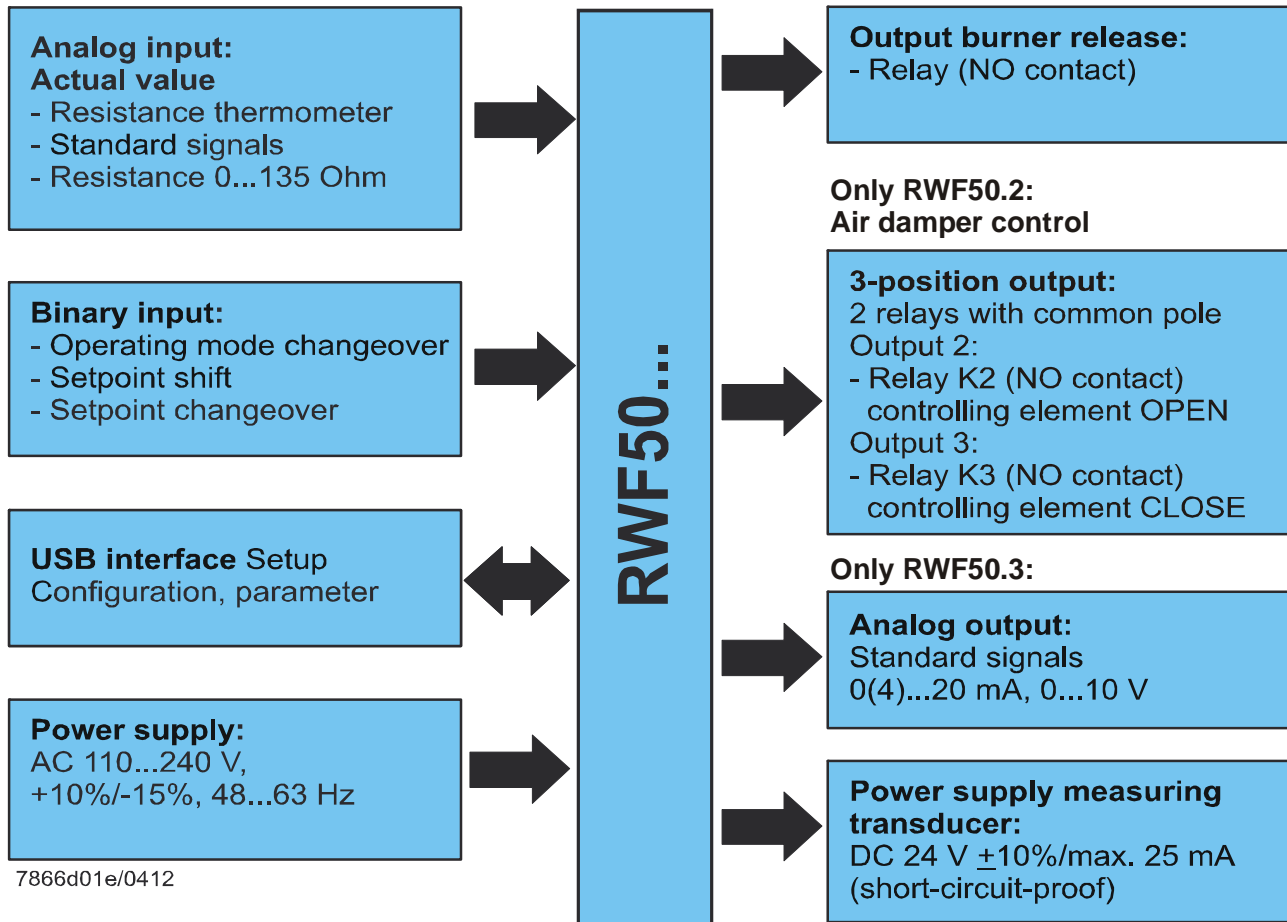

Figure 1: Block structure

## 2 Identification of product no.

### 2.1 Type field

**Location:**

The type field is glued onto the housing. The arrow below indicates the product no.

Example

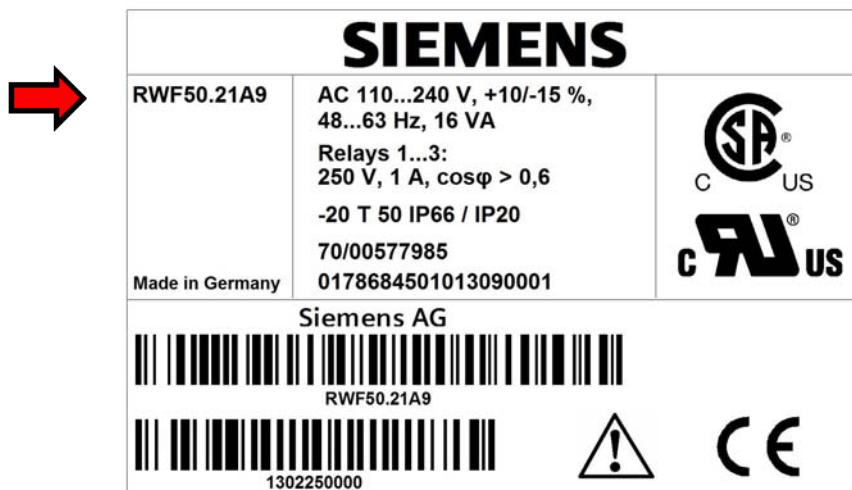

#### Attention!

Mains supply must correspond to the operating voltage given on the type field.

**Product nos. :**

Product no.	Description
RWF50.20A9	Basic version with 3-position output – single pack
RWF50.21A9	Basic version with 3-position output – multipack
RWF50.30A9	Basic version with analog output – single pack
RWF50.31A9	Basic version with analog output – multipack

### 2.2 Scope of delivery

- Type of controller as ordered
- User Manual

# 3 Installation

## 3.1 Installation site and climatic conditions

- The installation site should be free from vibrations, dust and corrosive media
- The controller should be installed away from sources of electromagnetic fields, such as variable speed drives or high-voltage ignition transformers

Relative humidity:  $\leq 95\%$  (noncondensing)

Ambient temperature:  $-20 \dots 50 \text{ }^\circ\text{C}$

Storage temperature:  $-40 \dots 70 \text{ }^\circ\text{C}$

## 3.2 Dimensions

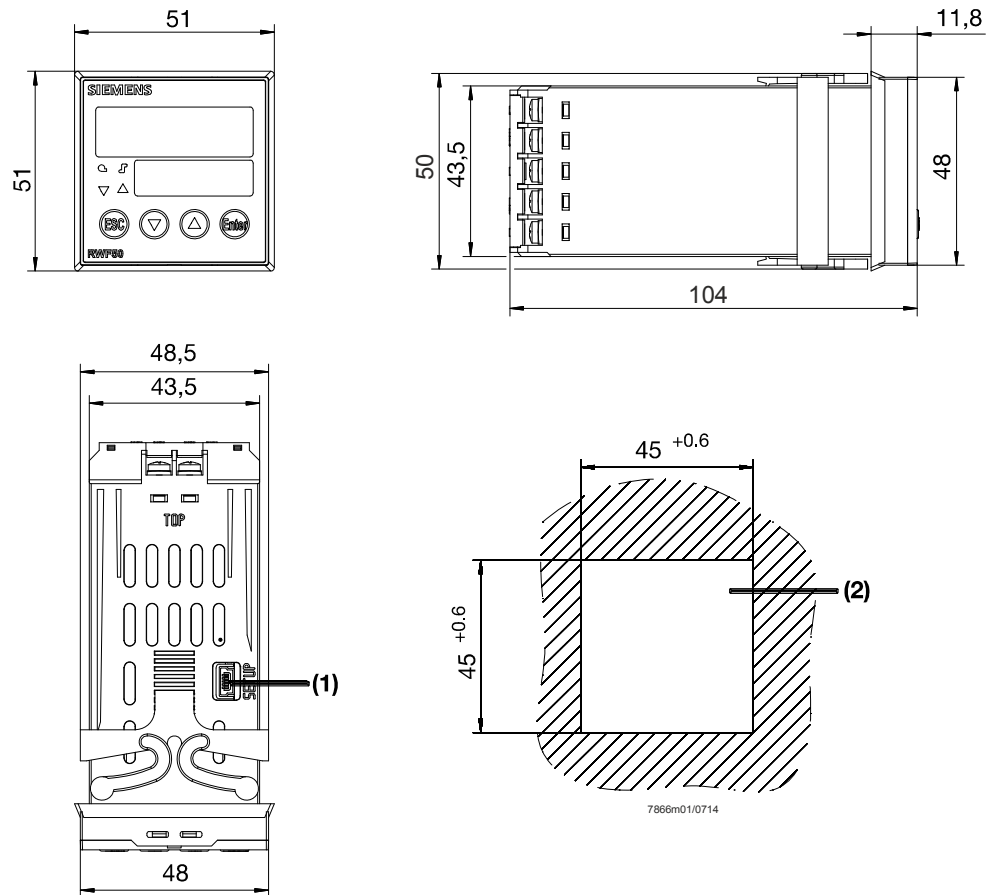

Figure 2: Dimensions of RWF50...

Key

- (1) USB interface setup
- (2) Panel cutout

### 3.3 Side-by-side mounting

If several controllers are mounted side-by-side or above one another in a control panel, the horizontal distance between panel cutouts must be a minimum of 11 mm and the vertical distance a minimum of 50 mm.

### 3.4 Mounting the controller in a panel cutout

- \* Remove the frame
- \* Fit the seal supplied with the controller



#### Attention!

The controller must be installed with the seal, preventing water or dirt from entering the housing!

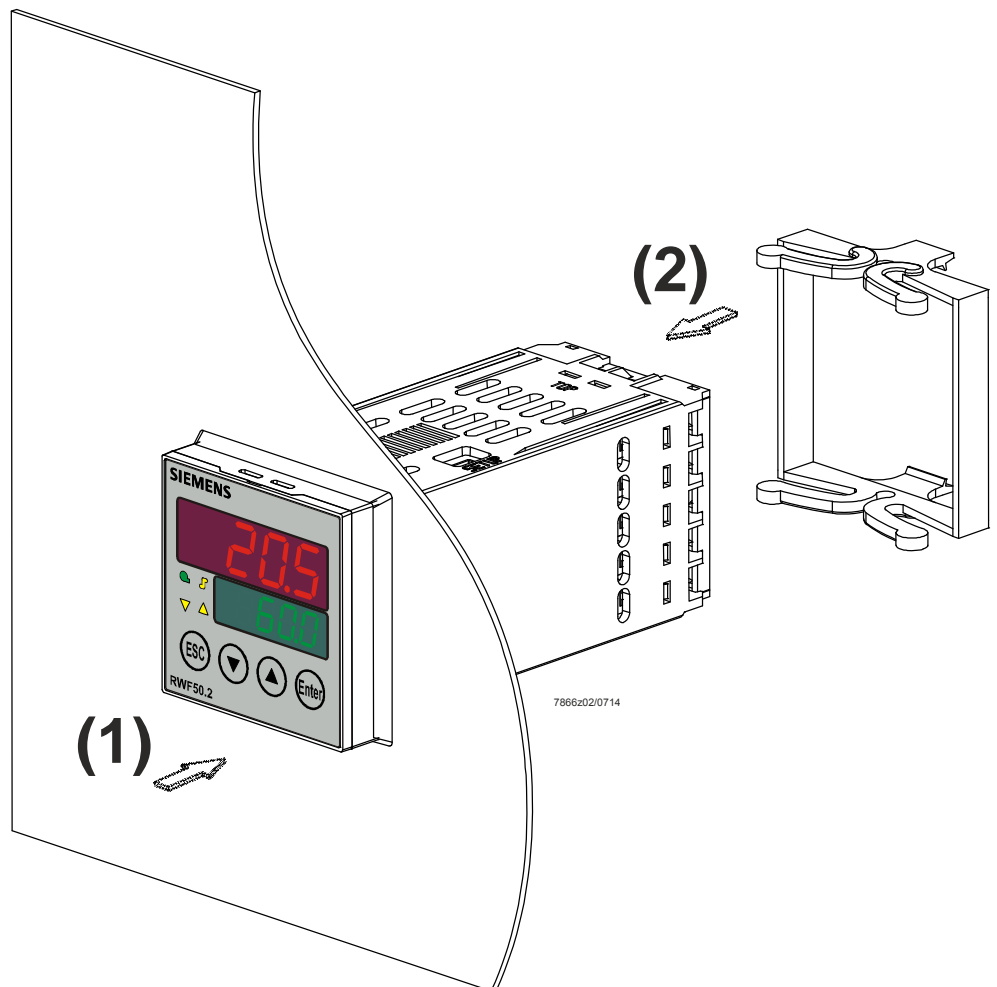

Figure 3: Mounting in a panel cutout

- \* Insert the controller from the front into the panel cutout (1) and make certain the seal is correctly fitted
- \* Fit the frame from the rear (2) and let it engage in the grooves

### 3.5 Removing the controller from the panel cutout



**Attention!**

When removing the controller, make certain that all cables are disconnected and that they do not get squeezed between control panel and housing.

### 3.6 Cleaning the front

The front of the controller can be cleaned with normal washing/rinsing agents or detergents.



**Attention!**

The front of the controller is **not** resistant to corrosive acids, caustic solutions and abrasive cleaners. Do not clean with high-pressure cleaners!



# 4 Electrical connections

## 4.1 Installation notes

### Safety regulations

- The choice of cable, installation and electrical connections of the controller must conform to VDE 0100 *Regulations for the installation of power circuits with nominal voltages below AC 1000 V*, or the relevant local regulations
- The electrical connections must be made by qualified personnel
- If contact with live parts is possible while working on the unit, the controller must be disconnected from power supply (all-polar disconnection)

### Connection of external components



#### Caution!

When connecting external components to the safety extra low-voltage inputs or outputs of the RWF50... (terminals 11, 12, 13, D1, DG, G+, G-, A+, A-, and USB port), it must be made certain that no dangerous active voltage are introduced to the RWF50...

This can be achieved by using capsulated components with double/reinforced insulation or SELV components, for example. If not observed, there is a risk of electric shock.

### Screw terminals



#### Caution!

All screw terminals at the rear of the unit must always be properly tightened. This applies to unused terminals as well.

### Fusing



#### Caution!

- Fusing on site must not exceed 20 A
- The fuse on the controller side (AC 250 V/1.6 A slow) conforms to IEC 60127-4
- To prevent the relay contacts from welding in the event of short-circuit in the load circuit, fusing of the output relays must give consideration to the maximum permissible relay current
  - ⇒ Reference!  
See chapter 12.3 *Controller outputs* OutP.
- No other loads may be connected to the controller's main power supply terminals

### Suppression of interference

- The electromagnetic compatibility and interference suppression levels conform to the standards and regulations listed under *Technical data*
  - ⇒ Reference!  
See chapter 12.5 *Electrical data*.
- Input, output and supply cables should be routed separately, not parallel to one another
- All input and output lines without connection to the power supply network must be shielded and twisted. They must not be run close to live components or live cables. On the controller side.

### Incorrect use

- The controller is not suited for installation in areas with explosion hazard
- Incorrect settings on the controller (setpoint, data of parameter and configuration levels) can affect proper functioning of the process or lead to damage. Safety devices independent of the controller, such as overpressure relief valves or temperature limiters/monitors should therefore always be provided, and only be capable of adjustment by qualified personnel. Please observe the relevant safety regulations. Since self-setting cannot be expected to handle all possible control loops, the stability of the resulting actual value should be checked

## 4.2 Galvanic separation

The illustration shows the maximum test voltages between the electrical circuits.

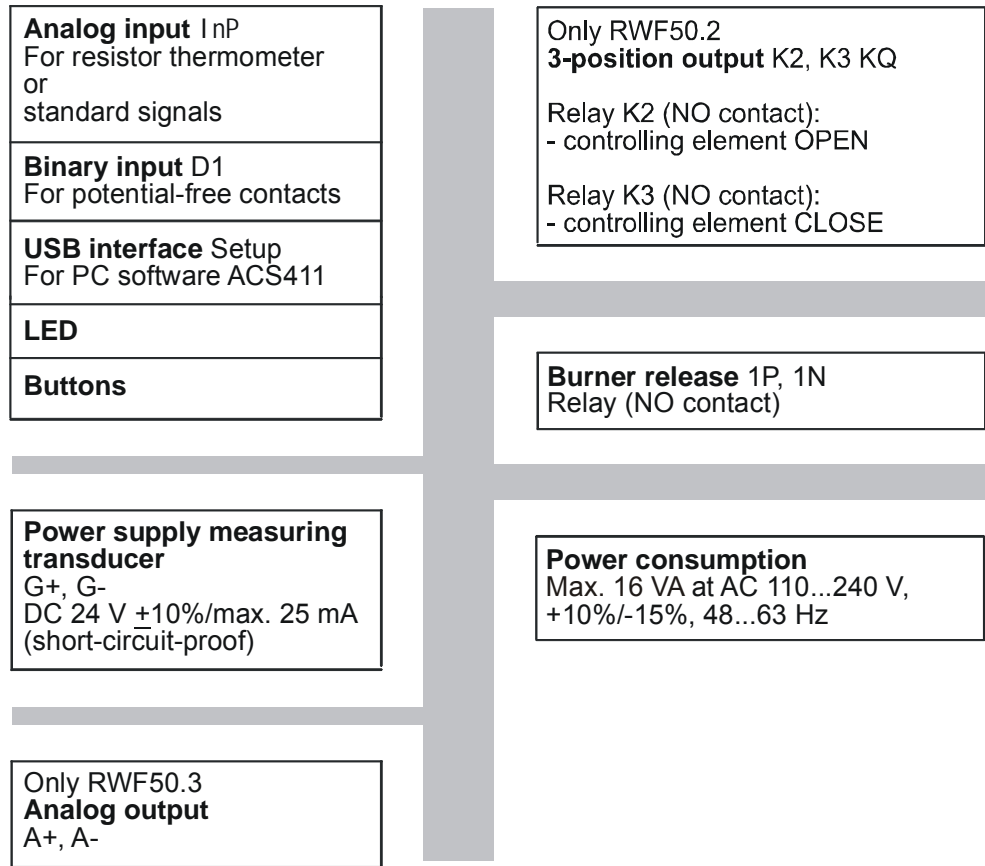

7866d02e/1212

### Isolation test voltages:

DC 50 V	
AC 1500 V	
AC 3300 V	

Figure 4: Test voltages

## 4.3 Assignment of terminals



### Caution!

Electrical connections must always be made by qualified personnel!

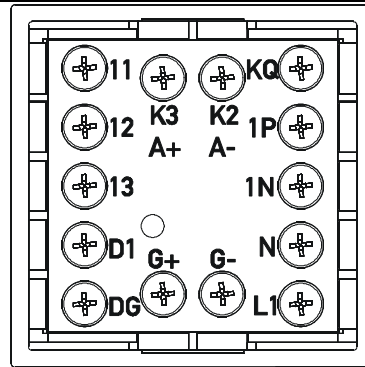

7866z09/0911

Figure 5: Assignment of terminals

Outputs	Display LED	Terminal no.	Connection diagram
Relay <i>Burner release</i> : Relay K1: P, 1N		1P pole  1N NO contact	<p>7866a01/0911</p>
Only RWF50.2 3-position output: Relay K3: Controlling element CLOSE Relay K2: Controlling element OPEN	  	K3 NO contact  KQ common pole  K2 NO contact	<p>7866a02/0911</p>
Only RWF50.3 Analog output A+, A- DC 0(4)...20 mA, DC 0...10 V		A+  A-	<p>7866a03/0911</p>

Analog input I nP1	Terminal no.	Connection diagram
Resistance thermometer in 3-wire circuit	11	
	12	
	13	
Resistance thermometer in 2-wire circuit	11	
	13	
Current input DC 0...20 mA, 4...20 mA	12	
	13	
Voltage input DC 0...5 V, 1...5 V, 0...10 V	11	
	13	

Binary inputs bi nF	Terminal no.	Connection diagram
Binary input D1	D1	
Common ground DG	DG	

Power supply	Terminal no.	Connection diagram
Power supply AC 110...240 V +10%/-15%, 48...63 Hz	L1 Live conductor	
	N Neutral conductor	
Power supply measuring transducer (short-circuit-proof)	G+	
	G-	

# 5 Operating modes

## 5.1 Low-fire operation

Low-fire operation means that only small amounts of heat are drawn from the boiler. Using relay K1 *Burner release*, the 2-position controller ensures control to the setpoint by switching the burner on and off like a thermostat.

### Thermostat function

This mode of control is known as the thermostat function. An adjustable switching differential ensures that the burner's switching frequency can be selected, aimed at reducing wear.

### Heating controller

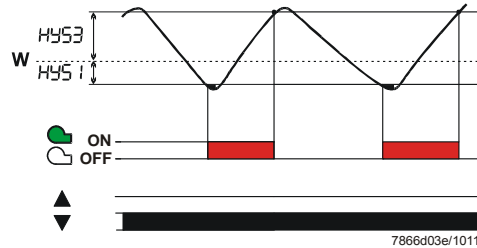

**Modulating and 2-stage operation:** Actual value lies between switch-on threshold HYS1 and switch-off threshold HYS3.

Figure 6: Control sequence of heating controller

### Cooling controller

If the controller is set to cooling mode, temperature limits HYS4 and HYS6 apply. In that case, relay K1 *Burner release* is used for controlling the cooling equipment.

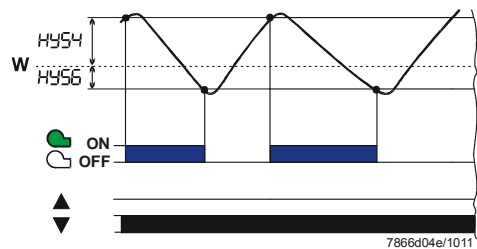

**Modulating and 2-stage operation:** Actual value lies between switch-on threshold HYS4 and switch-off threshold HYS6.

Figure 7: Control sequence of cooling controller

## 5.2 High-fire operation

High-fire operation means that large amounts of heat are drawn from the boiler so that the burner runs continuously. If the heating load during low-fire operation rises to a level where the actual value begins to fall below switch-on threshold HYS1, the controller will not immediately switch to a higher burner output, but first makes a dynamic test of the control deviation and switches to the higher output only when an adjustable threshold (q) is exceeded (A).

⇒ Reference!  
See chapter 5.5 *Response threshold (q)*.

### Operating mode changeover

- In high-fire operation – depending on the application – the burner can be fired in **modulating** or **2-stage** operation, then burning larger amounts of fuel than in low-fire operation. **Binary input D1** can be used to switch between modulating and 2-stage operation
  - Contacts **D1** and **DG** open: Modulating burner operation
  - Contacts **D1** and **DG** closed: 2-stage burner operation

⇒ Reference!  
See chapter 8.5 *Binary functions bi nF*.

### 5.2.1 Modulating burner, 3-position output

#### Only RWF50.2

Area (1) In area (1), the thermostat function is active. The lowest burner stage is switched on below switch-on threshold HYS1 and switched off above switch-off threshold HYS3.

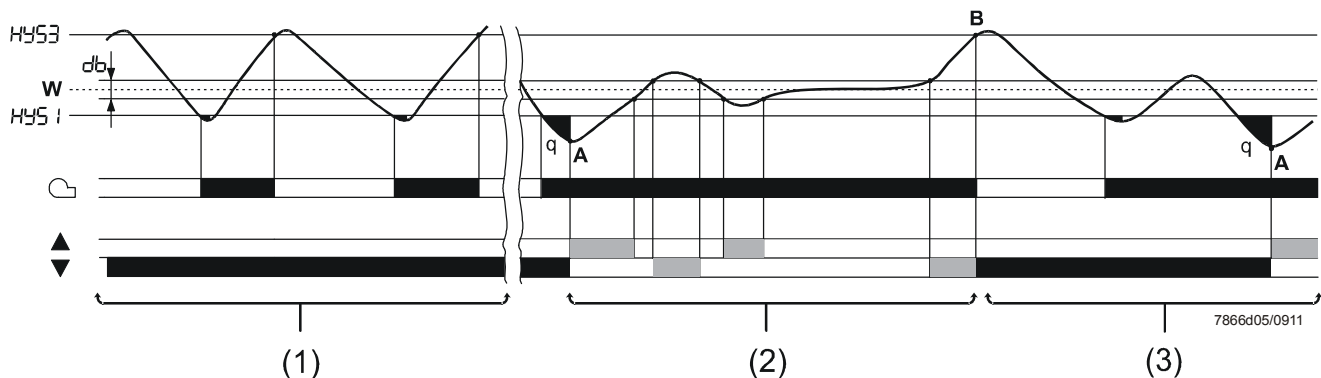

Figure 8: Control sequence of modulating burner, 3-position output

Area (2) Here, operating mode *Modulating burner* is shown. In high-fire operation, the 3-position controller acts on an actuator via relay K2 (OPEN) and relay K3 (CLOSE). When the actual value falls below the setpoint, the response threshold (q) at point (A) is reached and the controlling element opens (greater heat output). When the actual value lies within the dead band db, the controlling element remains inactive. When the actual value exceeds db, the controlling element closes (smaller heat output).

Area (3) If the actual value exceeds the upper switch-off threshold HYS3 in spite of the lowest heating stage, the controller switches the burner off (B). The controller only starts low-fire operation when the actual value falls below switch-on threshold HYS1 again. If the response threshold (q) is exceeded, the controller switches to high-fire operation (A).

⇒ Reference!  
See chapter 5.5 *Response threshold (q)*.

## 5.2.2 Modulating burner, analog output

### Only RWF50.3

Area (1) Thermostat function active.

Area (2) The RWF50.3 as a modulating controller provides control to the adjusted setpoint. Angular positioning is ensured via the analog output in the form of a standard signal.

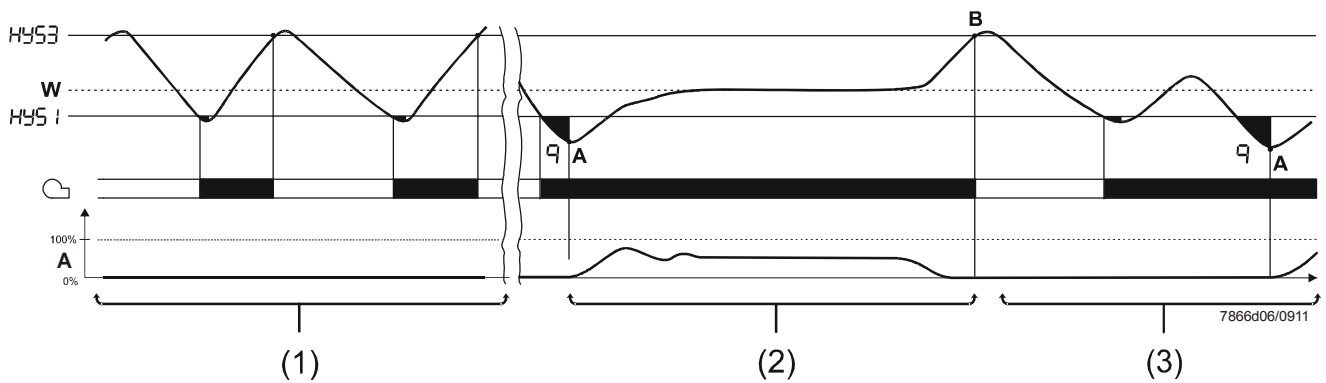

Figure 9: Control sequence of modulating burner, analog output

Area (3) The controller behaves as described in chapter 5.2.1 *Modulating burner, 3-position output*.

### Cooling controller

If the controller is set to cooling mode, the respective values HYS4 and HYS6 apply.

Starting from a high actual value, the controller now controls the connected cooling equipment in low-fire operation. In high-fire operation, the cooling output is controlled via relays K2 and K3 or the analog output. The response threshold (q) calculates automatically (now in the reverse sense) the point from which the cooling output is to be increased.

### 5.2.3 2-stage burner, 3-position output

#### Only RWF50.2

In area (1), the thermostat function is active. In area (2), the RWF50.2 as a **2-position controller** acts on the second stage via relay K2 (OPEN) and relay K3 (CLOSE) by switching on at switch-on threshold HYS1 and switching off at switch-off threshold HYS2.

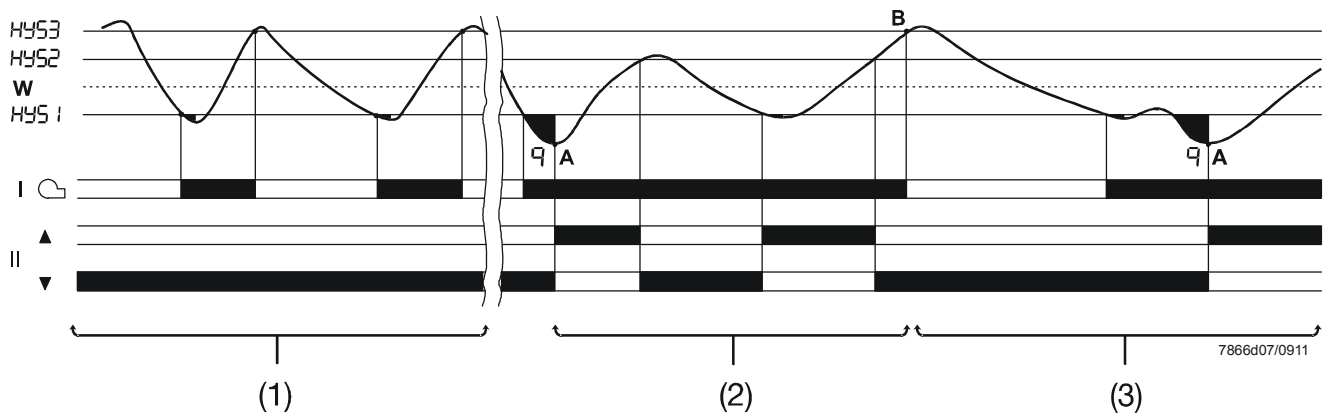

Figure 10: Control sequence of 2-stage burner, 3-position output

In area (3), the actual value exceeds the upper switch-off threshold HYS3 and the controller shuts down the burner (**B**). The controller only starts low-fire operation when the actual value falls again below switch-on threshold HYS1. If the response threshold (q) is exceeded, the controller switches to high-fire operation (**A**).



Reference!

See chapter 5.5 *Response threshold (q)*.



## 5.2.4 2-stage burner, analog output

### Only RWF50.3

In this case, a digital standard signal switches the second stage on via the analog output (terminals **A+** and **A-**) when reaching switch-on threshold **HYS1** and off at the lower switch-off threshold **HYS2**.

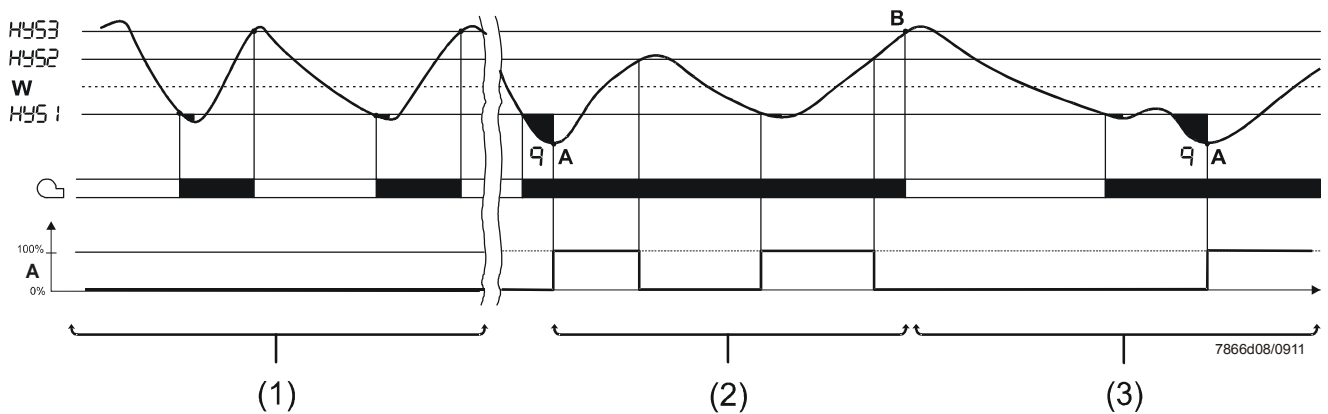

Figure 11: Control sequence of 2-stage burner, analog output

### Cooling controller

If the controller is set to cooling mode, the respective values of **HYS4**, **HYS5** and **HYS6** apply.

Starting from a high actual value, the controller now controls the connected cooling equipment in low-fire operation. In high-fire operation, the second stage and thus the cooling output are controlled via relays **K2** and **K3** or the analog output. The response threshold (**q**) calculates automatically (now in the reverse sense) the point from which the cooling output is to be increased.

## 5.3 Burner shutdown

In the event of a sensor failure at the analog input I nP1, the controller cannot monitor the actual value. Burner shutdown will automatically be triggered to guard against overheating.

### Functions

- Burner off
- 3-position output for closing the controlling element
- Self-setting function is ended
- Manual control is ended

## 5.4 Predefined setpoint

The setpoint is predefined within the selected setpoint limits via the buttons or the ACS411 software. Using an external contact, the setpoint can also be shifted or changed over.

⇒ Reference!  
See chapter 8.5 *Binary functions binF*.

### Setpoint changeover or setpoint shift

Depending on the function selected for the binary input, the effective controller setpoint can change between setpoint SP1 and setpoint SP2 or can be shifted by the amount of dSP. A contact at binary input D1 controls the changeover or shift.

Entry The values for setpoints SP1, SP2 and dSP are to be entered at the operating level.

⇒ Reference!  
See chapter 6 *Operation*.

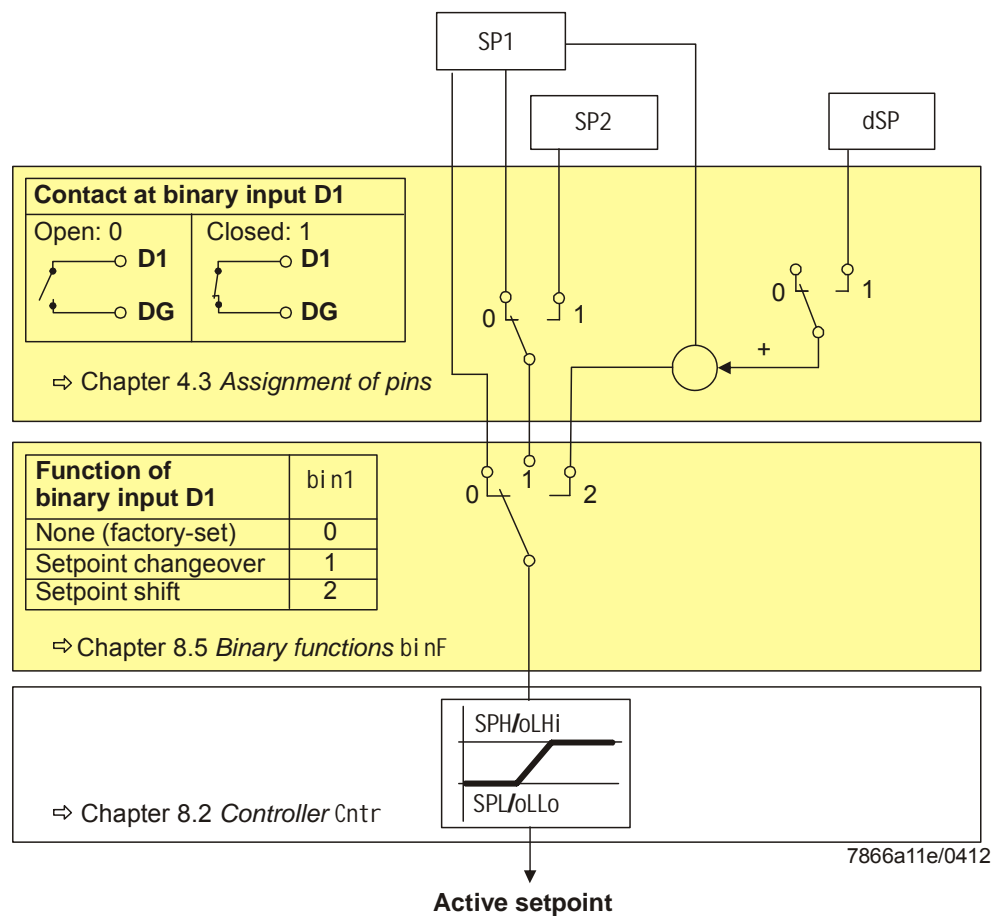

Figure 12: Setpoint changeover or setpoint shift

## 5.5 Response threshold (q)

The response threshold (q) defines for what period of time and how much the actual value is allowed to drop before the system switches to high-fire operation.

An internal mathematical calculation using an integration function determines the sum of all areas  $q_{eff} = q_1 + q_2 + q_3$  as shown in the graph. This takes place only when the control deviation  $(x-w)$  falls below the value of switch-on threshold HYS1. If the actual value increases, integration is stopped.

If  $q_{eff}$  exceeds the preset response threshold (q) (can be adjusted at the parameter level), this causes the second burner stage to switch on or – in the case of the 3-position controller/modulating controller – the controlling element to open.

If the current boiler temperature reaches the required setpoint,  $q_{eff}$  is reset to 0.

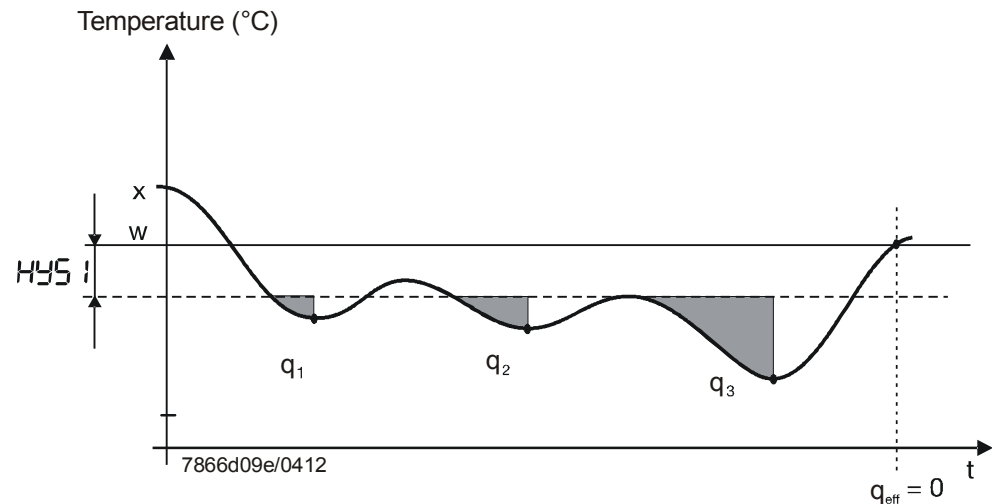

Figure 13: Control sequence response threshold (q)

In contrast to time-dependent switching on, load-dependent switching on offers the advantage of capturing the dynamics of the actual value.

Also, monitoring the progression of the actual value during the change from low-fire to high-fire ensures low switching frequencies to reduce wear and to extend running times.

### Cooling controller

The response threshold (q) also works (in the reverse sense) in the case of cooling mode.

## 5.6 Cold start of plant

### Interlocking



#### Note!

Functions *Cold start of plant* and *Thermal shock protection (TSS)* are interlocked. Only one function can be activated, but never both at the same time.

### Heating controller

When a heating system is switched off for a longer period of time, the actual value will drop of course.

To achieve a faster control response, the controller immediately starts in high-fire operation as soon as the control deviation ( $x-w$ ) drops below a certain limit value.

This limit is calculated as follows:

$$\text{Limit value} = 2 \times (\text{HYS1} - \text{HYS3})$$

In that case, the response threshold ( $q$ ) is inactive, independent of operating mode and controlled variable (temperature or pressure).

### Example

Operating mode: Modulating, 3-position output

HYS1 = -5 K

HYS3 = +5 K

$w = 60 \text{ }^\circ\text{C}$

$$\text{Limit value} = 2 \times (-5 - 5) = 2 \times (-10) = -20 \text{ K}$$

At an actual value below  $40 \text{ }^\circ\text{C}$ , heating up immediately starts in low-fire operation, and not in thermostat mode.

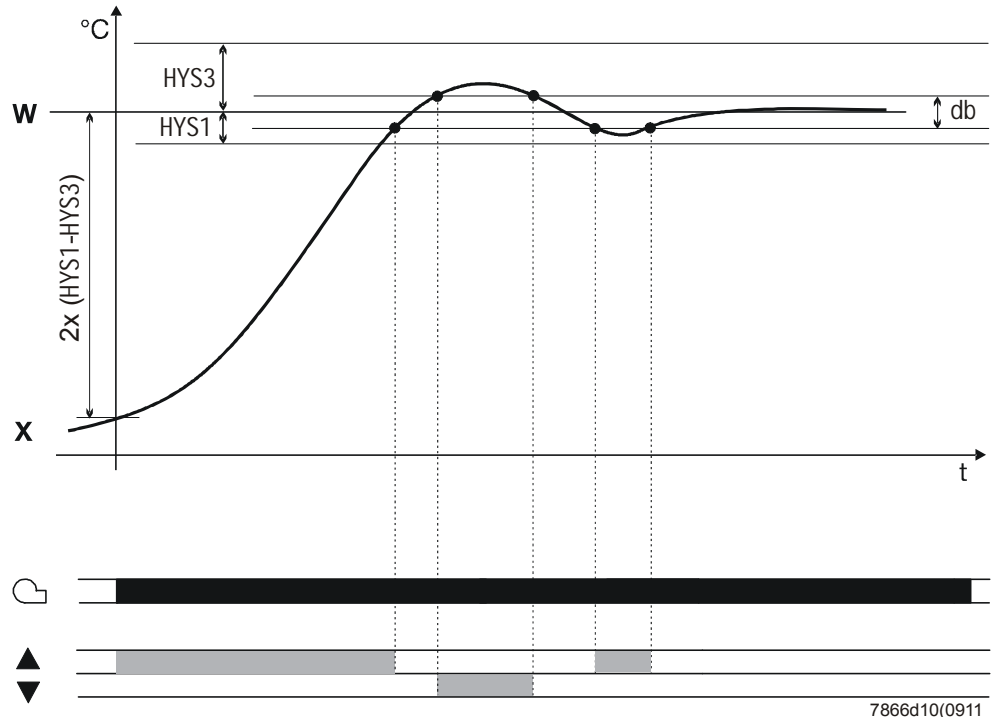

Figure 14: Control sequence *Cold start of plant*

7866d10(0911

## Cooling controller

Cold start of plant also works when the RWF50... is used as a cooling controller.

In that case, the limit value is calculated as follows:

Limit value =  $2 \times (\text{HYS4} - \text{HYS6})$

## Example

Operating mode: Modulating 3-position output

HYS4 = 5 K

HYS6 = -5 K

w = -30 °C

Limit value =  $2 \times (5 - (-5)) = 2 \times (10) = +20 \text{ K}$

When the actual value lies above -10 °C, cooling is immediately started in high-fire mode in place of low-fire mode.

## 5.7 Thermal shock protection (TSS)

### Interlocking



#### Note!

Functions *Cold start of plant* and *Thermal shock protection (TSS)* are interlocked. Only one function can be activated, but never both at the same time.

The controller comes with thermal shock protection (TSS) deactivated; it can be activated at the configuration level.



#### Reference!

See chapter 8.3 *Thermal shock protection (TSS)* rAFC.

### Function

The function is automatically activated when the actual value drops below the adjustable limit value  $rAL$  (exceeds the adjustable limit value with the cooling controller). In that case, the setpoint is approached via a ramp function.

Gradient and slope of the ramp  $rASL$  are adjustable. The setpoint ramp has a symmetrical tolerance band  $tolP$ . If, during the startup phase, the actual value leaves the tolerance band, the setpoint ramp is stopped until the actual value returns to a level within the tolerance band. The startup phase is ended when the setpoint of the ramp function reaches the final setpoint  $SP1$ .



#### Note!

When thermal shock protection (TSS) is active, the controller operates in low-fire operation. The response threshold ( $q$ ) is active.

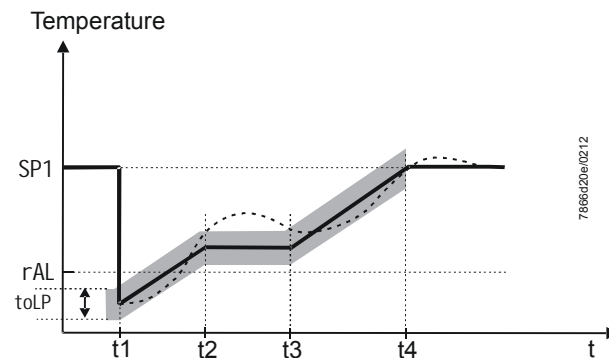

Figure 15: Thermal shock protection (TSS)

#### Key

- Setpoint (w)
- Actual value (x)

## 6 Operation

### 6.1 Meaning of display and buttons

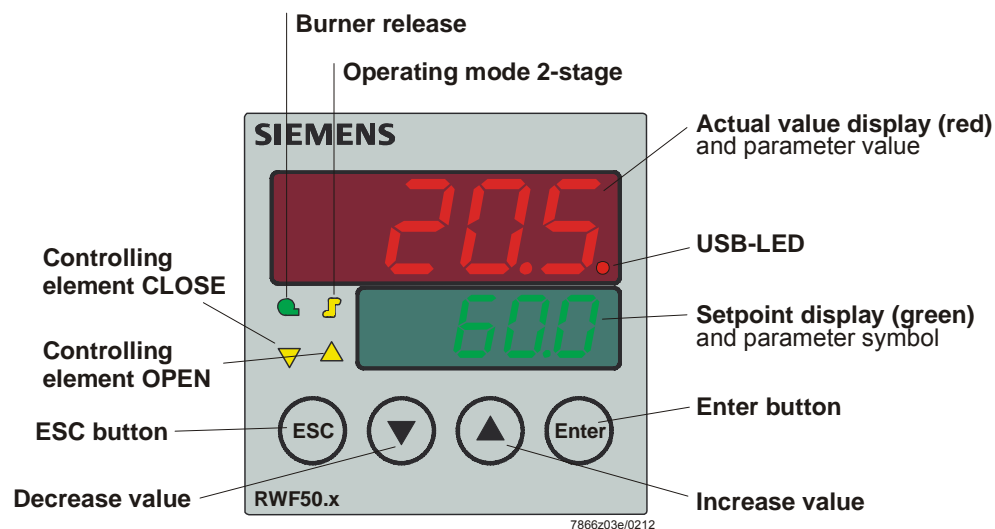

Figure 16: Meaning of display and buttons

#### Initialization

The two 7-segment displays (red and green) show hyphens and all LEDs light up for about 5 seconds.

#### Basic display

The upper display (red) shows the actual value.  
The lower display (green) shows the setpoint.

⇒ Reference!  
See chapter 8.6 *Display di SP.*

#### Parameter display

When entering parameters, the parameter symbol at the bottom (green) and the set value at the top (red) appear.

#### Self-setting function

The actual value is shown on the actual value display (red) and tUnE flashes on the setpoint display (green).

⇒ Reference!  
See chapter 9 *Self-setting function.*

#### Flashing actual value display

The actual value display (red) shows 9999 flashing.

⇒ Reference!  
See chapter 11 *What to do if ...*

#### Manual control

The setpoint display (green) shows HAnd flashing.

⇒ Reference!  
See chapter 6.4 *Manual control of a modulating burner.*



## 6.2 Basic display

When switching power on, the displays show hyphens for about 5 seconds.

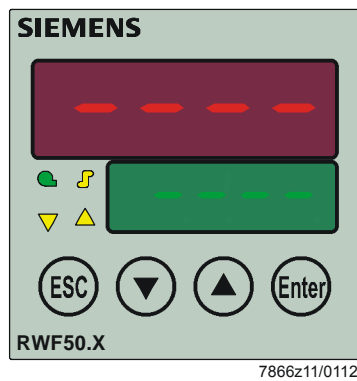

Figure 17: Display start

The state that follows is called *normal display*.

Default display is the actual value and the current setpoint.

Other values can be displayed at the configuration level or via PC software ACS411.

⇒ **Reference!**  
See chapter 8.6 *Display di SP*.

Manual control, self-setting, the user, parameter and configuration levels can be activated from here.

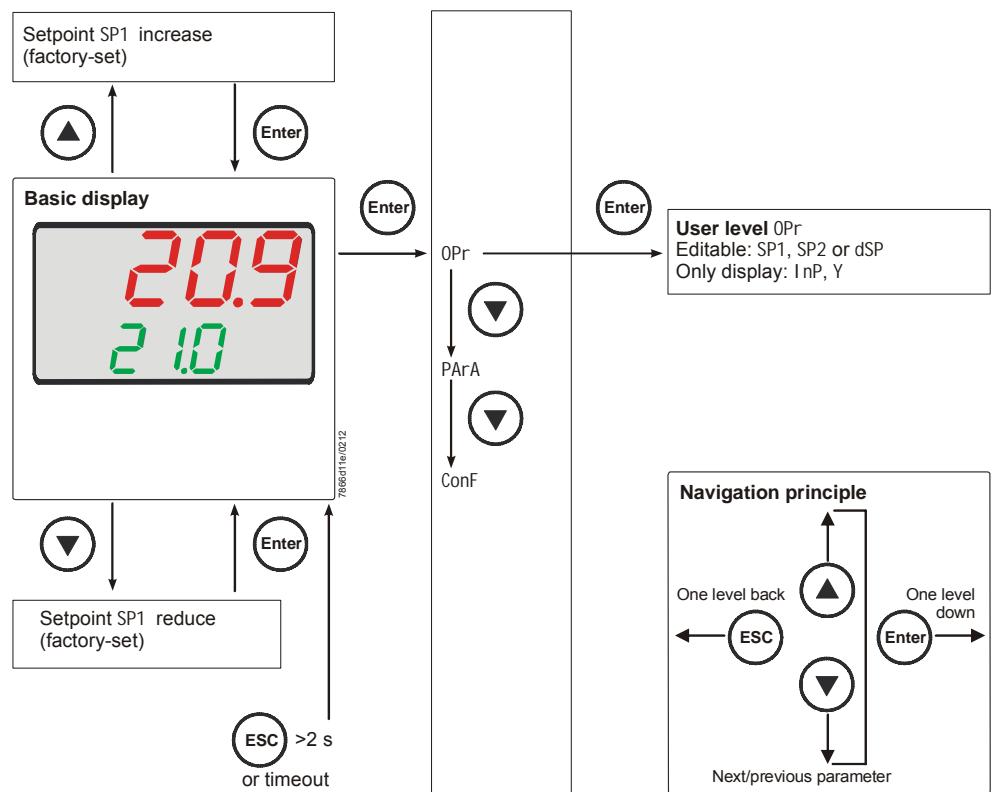

Figure 18: Basic display







## 6.3 User level

This level is started from the basic display.

Setpoints SP1, SP2 or dSP can be altered.

The values of I nP (analog input) and Y (current angular positioning between 0...100%) can be displayed.

### Changing the setpoints

- \* From the basic display, press  so that OPr appears
- \* Press  so that SP1 appears
- \* Press  and SP1 flashes
- \* Press  or  to adjust the required setpoint and press  to confirm

### Timeout

Timeout after about 180 seconds.



#### Note!

If the setpoint is not stored, the basic display changes after the timeout tout and the former setpoint is maintained.

The value changes only within the permitted range.

## 6.4 Manual control, modulating burner





### Note!

Manual control can only be activated if the thermostat function **energized** relay K1. If the thermostat function **deenergized** relay K1 during manual control, manual control is ended.

- \* Press  for 5 seconds

**HAnd** appears on the lower display, alternating with the value for manual control.

### RWF50.2 3-position controller



- \* Open and close fuel-air ratio control by pressing  and 

Relay K2 opens the controlling element as long as  is kept depressed.

Relay K3 closes the controlling element as long as  is kept depressed.

The 2 yellow arrows indicate when relay K2 opens or relay K3 closes the controlling element.

### RWF50.3 Modulating controller

- \* Change angular positioning by pressing  or 
- \* Adopt flashing new angular positioning by pressing 

Per default, the analog output delivers the current angular positioning.

- \* Return to automatic operation by keeping  depressed for 5 seconds



### Note!

When activating manual control, angular positioning is set to 0 until another entry is made.

## 6.5 Manual control, 2-stage burner

- \* Press  for 5 seconds
- \* Press  briefly

RWF50.2	RWF50.3
Relay K2 is active Relay K3 is inactive	The analog output delivers the highest value (depending on setting DC 10 V or 20 mA)
Controlling element opens	

- \* Or press  briefly

RWF50.2	RWF50.3
Relay K2 is inactive Relay K3 is active	The analog output delivers the lowest value (depending on setting DC 0 V, 4 mA, or 0 mA)
Controlling element closes	



- \* Return to automatic operation by pressing  for 5 seconds



### Note!

If the thermostat function **deenergizes** relay K1 during manual control, manual control is ended.

## 6.6 Starting the self-setting function

**Start** \* Press  +  for 5 seconds

**Cancel** \* Cancel with  + 

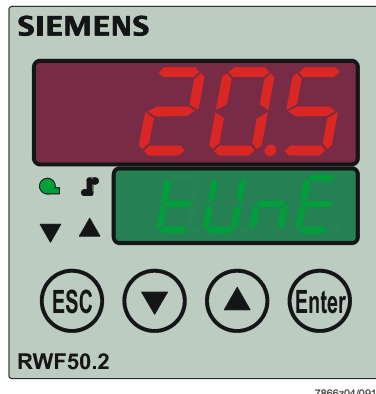

Figure 19: Display of self-setting function

When **tUnE** stops flashing, the self-setting function has been ended.

The parameters calculated by the controller are automatically adopted!



**Note!**

It is not possible to start **tUnE** in manual control or low-fire operation.

## 6.7 Display of software version

\* Press  + 



Figure 20: Display of software version

### Segment test

\* Press  +  again.

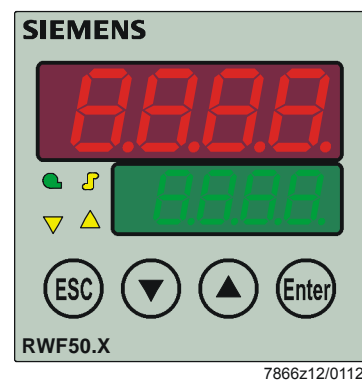

Figure 21: Display segment test

All display segments and LEDs light up; the actual value display (red) flashes for about 10 seconds.

## 7 Parameterization PArA

Here, set the parameters associated directly with the controller's adaptation to the controlled system after the plant has been put into operation.



### Note!

The display of the individual parameters depends on the type of controller.

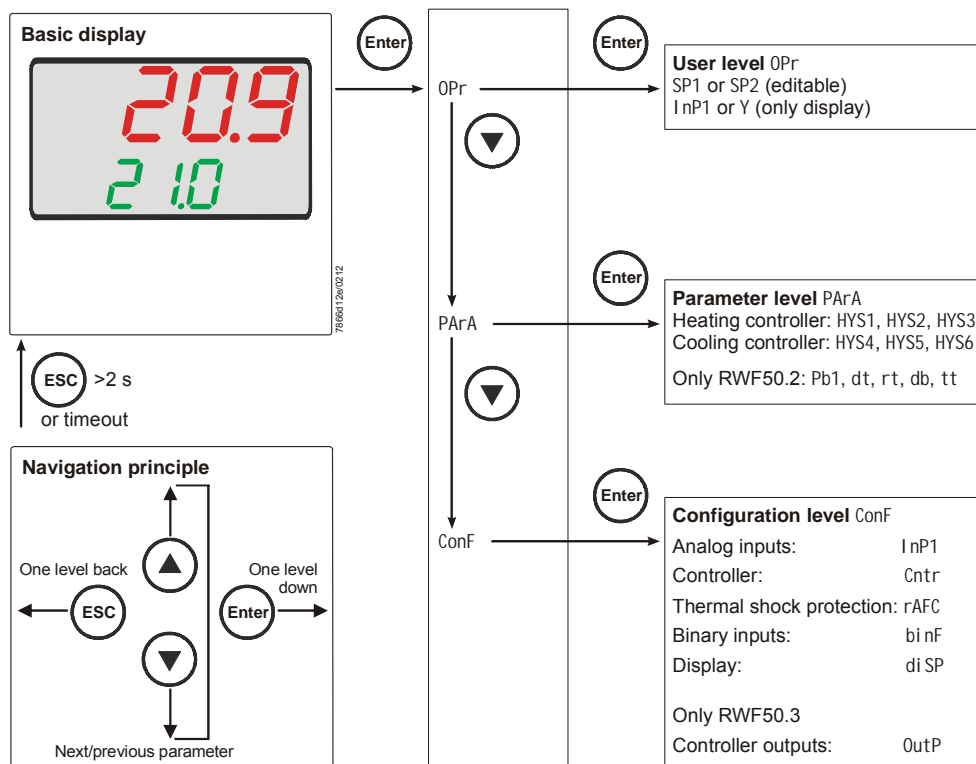

Figure 22: Parameterization

Access to this level can be locked.



### Reference!

See chapter 8.6 *Display di SP*.

- \* From the basic display, press **Enter** so that OPr appears
- \* Press **Down** so that PArA appears
- \* Press **Enter** so that the first parameter of the parameter level is displayed

Display of controller parameters

The parameters are shown on the lower setpoint display (green) and their values on the upper/actual value display (red).

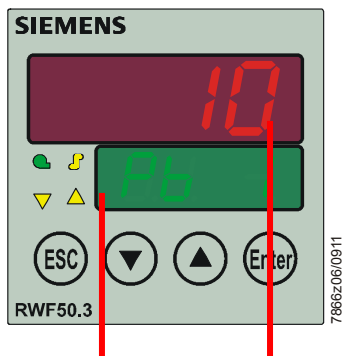

Parameter	Display	Value range	Factory setting	Remarks
Proportional band <sup>1</sup>	Pb1	1...9999 digit	10	Influences the controller's P-action
Derivative time	dt	0...9999 s	80	Influences the controller's D-action With dt = 0, the controller has no D-action
Integral action time	rt	0...9999 s	350	Influences the controller's I-action With rt = 0, the controller has no I-action
Dead band (neutral zone) <sup>1</sup>	db	0.0...999.9 digit	1	For 3-position output 
Controlling element running time	tt	10...3000 s	15	Running time of the positioning valve for use with modulating controllers
Switch-on threshold Heating controller <sup>1</sup>	HYS1	-1999...0.0 digit	-5	⇒ Reference! See chapter 5.2 <i>High-fire operation</i>
Switch-off threshold stage II Heating controller <sup>1</sup>	HYS2	0.0...HYS3 digit	3	⇒ Reference! See chapter 5.2 <i>High-fire operation</i>
Switch-off threshold Heating controller <sup>1</sup>	HYS3	0.0...9999 digit	5	⇒ Reference! See chapter 5.2 <i>High-fire operation</i>
Switch-on threshold Cooling controller <sup>1</sup>	HYS4	0.0...9999 digit	5	⇒ Reference! See chapter 5.2 <i>High-fire operation</i>
Switch-off threshold stage II Cooling controller <sup>1</sup>	HYS5	HYS6...0.0 digit	-3	⇒ Reference! See chapter 5.2 <i>High-fire operation</i>
Switch-off threshold Cooling controller <sup>1</sup>	HYS6	-1999...0.0 digit	-5	⇒ Reference! See chapter 5.2 <i>High-fire operation</i>
Response threshold	q	0.0...999.9	0	⇒ Reference! See chapter 5.5 <i>Response threshold (q)</i>

<sup>1</sup> Setting of decimal place has an impact on this parameter

**Note!**  
 When using the RWF50... as a modulating controller only, or as a modulating controller without the burner release function (1P, 1N), parameter HYS1 must be set to 0 and parameters HYS2 and HYS3 must be set to their **maximum** values.  
 Otherwise, for example, when using default parameter HYS1 (factory setting -5), the 3-position controller is only released when the control deviation reaches -5 K.



# 8 Configuration ConF

Here, the settings (e.g. acquisition of measured value or type of controller) required directly for commissioning a certain plant are made and, for this reason, there is no need to change them frequently.

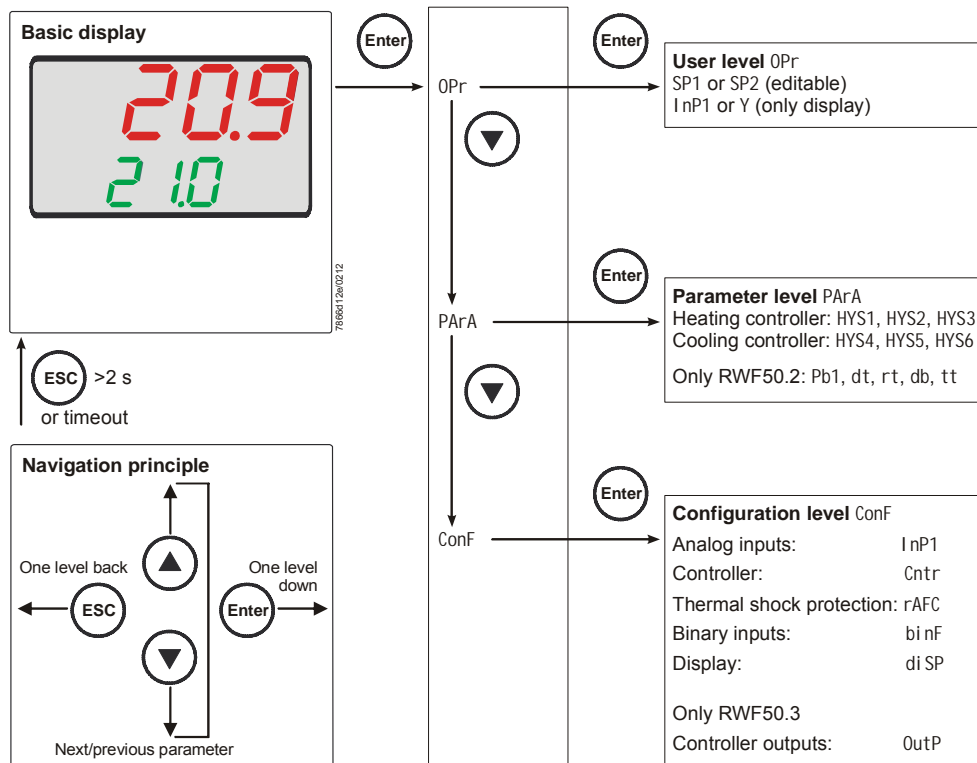

Figure 23: Configuration

Access to this level can be locked.

⇒ **Reference!**  
See chapter 8.6 *Display di SP*.

👉 **Note!**  
The following tables show the default settings in columns *Value/selection* and *Description* in **bold printing**.

## 8.1 Analog input InP1

An analog input is available.

ConF → InP → InP1 →

Parameter	Value/ selection	Description									
<b>Sensor type</b> SEn1 Sensor type	1 2 3 4 5 6 7 15 16 17 18 19	<b>Resistance thermometer Pt100, 3-wire</b> Resistance thermometer Pt100, 2-wire Resistance thermometer Pt1000, 3-wire Resistance thermometer Pt1000, 2-wire Resistance thermometer LG-Ni1000, 3-wire Resistance thermometer LG-Ni1000, 2-wire 0...135 Ohm 0...20 mA 4...20 mA DC 0...10 V DC 0...5 V DC 1...5 V									
<b>Correction of measured value</b> OFF1 Offset	-1999... 0... +9999	Using the measured value correction (offset), a measured value can be corrected to a certain degree, either up or down  <b>Example:</b>  <table> <thead> <tr> <th>Measured value</th> <th>Offset</th> <th>Displayed values</th> </tr> </thead> <tbody> <tr> <td>294.7</td> <td>+0.3</td> <td>295.0</td> </tr> <tr> <td>295.3</td> <td>-0.3</td> <td>295.0</td> </tr> </tbody> </table>	Measured value	Offset	Displayed values	294.7	+0.3	295.0	295.3	-0.3	295.0
Measured value	Offset	Displayed values									
294.7	+0.3	295.0									
295.3	-0.3	295.0									
 <b>Caution!</b> <b>Measured value correction:</b> To make the calculation, the controller uses the corrected value (displayed value). This value does not represent the value acquired at the point of measurement. If not correctly used, inadmissible values of the control variable can be produced. Measured value corrections must therefore be made within certain limits only.											
<b>Start of display</b> SCL1 Scale low level	-1999... 0... +9999	In the case of a measuring transducer with standard signal, the physical signal is assigned a display value here  Example: 0...20 mA = 0...1500 °C									
<b>End of display</b> SCH1 Scale high level	-1999... 100... +9999	The range of the physical signal can be crossed by 20%, either up or down, without getting a signal informing about the crossing									
<b>Filter time constant</b> dF1 Digital filter	0.0... 0.6... 100.0...	Is used to adapt the digital 2nd order input filter (time in s; 0 s = filter OFF)  If the input signal changes abruptly, about 26% of the change are captured after a time corresponding to the filter time constant dF (2 x dF: approx. 59%; 5 x dF: approx. 96%)  When the filter time constant is great: - Great attenuation of interference signals - Slow response of actual value display to changes of the actual value - Low limit frequency (low-pass filter)									
<b>Temperature unit</b> Unit Temperature unit	1 2	<b>Degrees Celsius</b> <b>Degrees Fahrenheit</b>  Unit of temperatures									

## 8.2 Controller Cntr

Here, the type of controller, operating action, setpoint limits and presettings for self-optimization are selected.



ConF → Cntr →

Parameter	Value/ selection	Description
<b>Controller type</b> CtYP Controller type	1 2	3-position controller (RWF50.2) Modulating controller (RWF50.3)
<b>Operating action</b> CAcT Control direction	1 0	<p><b>Heating controller</b> Cooling controller</p> <p>(0) = cooling controller: The controller's angular positioning (Y) is &gt;0 when the actual value (x) lies above the setpoint (w)</p> <p>(1) = heating controller: The controller's angular positioning (Y) is &gt;0 when the actual value (x) lies below the setpoint (w)</p> <p style="text-align: right; font-size: small;">7866d14/0512</p>
<b>Setpoint limitation start</b> SPL Setpoint limitation low	-1999... +9999	Setpoint limitation prevents values from being entered outside the defined range.
<b>Setpoint limitation end</b> SPH Setpoint limitation high	-1999... +9999	
<b>Self-optimization</b>	0 1	<p><b>Free</b> Locked</p> <p>Self-optimization can only be disabled or enabled via the ACS411 setup program</p> <p>If disabled via ACS411 PC software, self-optimization cannot be started via the controller's buttons</p> <p>Setting in the ACS411 setup program → Controller → Self-optimization</p> <p>Self-optimization is also disabled when the parameter level is locked</p>
<b>Lower working range limit</b> oLLo Lower operation range limit	-1999... +9999	<p> <b>Note!</b> If the setpoint with the respective hysteresis exceeds the upper working range limit, the switch-on threshold is substituted by the working range limit.</p>
Upper working range limit oLHi Upper working range limit	-1999... +9999	<p> <b>Note!</b> If the setpoint with the respective hysteresis drops below the lower working range limit, the switch-off threshold is substituted by the working range limit.</p>

## 8.3 Thermal shock protection (TSS) rAFC

The RWF50... can be operated as a fixed value controller with or without ramp function.

ConF → rAFC →

Parameter	Value/ selection	Description
<b>Function</b> FnCt Function	<b>0</b> 1 2	<b>Switched off</b> Gradient Kelvin/minute Gradient Kelvin/hour   <div style="background-color: #ffffcc; padding: 5px;"> <p><b>Note!</b> With FnCt = 1 or 2, <i>Thermal shock protection (TSS)</i> is automatically activated as soon as the actual value drops below the adjustable absolute limit value rAL (heating controller) or exceeds it (cooling controller).</p> </div>
<b>Ramp slope</b> rASL Ramp slope	<b>0.0...</b> 999.9	Slope of ramp slope (only with functions 1 and 2)
<b>Tolerance band ramp</b> toLP Tolerance band ramp	<b>2 x  HYS1 </b> = <b>10...9999</b>	Width of tolerance band (in K) about the setpoint (only with function 1 and 2)  Heating controller: Smallest possible factory setting: <b>2 x  HYS1  = 10 K</b> To monitor the actual value in connection with thermal shock protection (TSS), a tolerance band can be laid about the setpoint curve. If the limit values are crossed, the ramp is stopped.   <div style="background-color: #ffffcc; padding: 5px;"> <p><b>Reference!</b> See chapter 5.7 <i>Thermal shock protection (TSS)</i>.</p> </div> Cooling controller: Smallest possible factory setting: <b>2 x  HYS4  = 10 K</b>
	<b>Note!</b>	In the event of a faulty sensor or manual control, the ramp function is stopped. The outputs behave the same way they do when the measuring range is crossed (configurable). Functions <i>Cold start of plant</i> and <i>Thermal shock protection (TSS)</i> are interlocked. Only one function can be activated, but never both at the same time.
<b>Limit value</b> rAL Ramp limit	<b>0...250</b>	<b>Heating controller:</b> If the actual value lies below this limit value, the setpoint is approached in the form of a ramp until final setpoint SP1 is reached.  <b>Cooling controller:</b> If the actual value lies above this limit value, the setpoint is approached in the form of a ramp until final setpoint SP1 is reached.

## 8.4 Control outputs OutP

With the RWF50.2, configuration of the outputs relates to the binary outputs (K2 and K3), and with the RWF50.3, to the analog outputs (A+ and A-). The burner is released via relay K1.

The switching states of relay K1 *Burner release* (LED green), relay K2 *Controlling element OPEN*, and relay K3 *Controlling element CLOSE* (yellow LED arrows) are indicated on the controller front.

Only RWF50.2...  
Binary outputs

The binary outputs of the RWF50.2 offer no setting choices.

Only RWF50.3...  
Analog output

The RWF50.3 has an analog output.

The analog output offers the following setting choices:

ConF → OutP →

Parameter	Value/ selection	Description
<b>Function</b> FnCt Function	1 <b>4</b>	Analog input InP1 is delivered <b>Controller's angular positioning is delivered (modulating controller)</b>
<b>Signal type</b> Si Gn Type of signal	<b>0</b> 1 2	<b>0...20 mA</b> 4...20 mA DC 0...10 V  Physical output signal
<b>Value when out of range</b> rOut Value when out of range	<b>0...101</b>	Signal (in percent) when measuring range is crossed  101 = last output signal
<b>Zero point</b> OPnt Zero point	-1999... <b>0...</b> +9999	A value range of the output variable is assigned to a physical output signal
<b>End value</b> End End value	-1999... <b>100...</b> +9999	

## 8.5 Binary input bi nF

This setting decides on the use of the binary input.

⇒ Reference!  
See chapter 5.4 *Predefined setpoint*.

ConF → bi nF →

Parameter	Value/ selection	Description
<b>Binary input</b> bi n1 Binary inputs	<b>0</b> 1 2 4	<b>No function</b> Setpoint changeover Setpoint shift Changeover of operating mode  Burner modulating: Contacts D1 and DG open  Burner 2-stage: Contacts D1 and DG closed

## 8.6 Display di SP

By configuring the position of the decimal point and automatic changeover (timer), both LED indications can be adapted to the respective requirements. Timeout tout for operation and the locking of levels can be configured as well.

ConF → di SP →

Parameter	Value/ selection	Description
<b>Upper display</b> di SU Upper display	0 <b>1</b> 4 6 7	Display value for upper display  Switched off <b>Analog input I nP1</b> Controller's angular positioning Setpoint End value with thermal shock protection
<b>Lower display</b> di SL Lower display	0 1 4 <b>6</b> 7	Display value for lower display  Switched off Analog input I nP1 Controller's angular positioning <b>Setpoint</b> End value with thermal shock protection
<b>Timeout</b> tout	0... <b>180...</b> 255	Time (s) on completion of which the controller returns automatically to the basic display, if no button is pressed
<b>Decimal point</b> dECP Decimal point	<b>0</b> 1 2	<b>No decimal place</b> One decimal place Two decimal places  If the value to be displayed cannot be shown with the programmed decimal point, the number of decimal places is automatically reduced. If the measured value drops again, the number of decimal places is increased until the programmed value is reached
<b>Locking of levels</b> CodE	<b>0</b> 1 2 3	<b>No locking</b> Locking of configuration level Locking of parameter level Locking of keyboard

## 9 Self-setting function

### 9.1 Self-setting function in high-fire operation



Note!

tUnE is only possible in high-fire operation, in *modulating burner* mode.

Self-setting function tUnE is a proper software function unit integrated in the controller. In *modulating* mode, tUnE tests in high-fire operation the response of the controlled system to angular positioning steps according to a special procedure. A complex control algorithm uses the response of the controlled system (actual value) to calculate and automatically store the control parameters for a PID or PI controller (set  $dt = 0!$ ). The tUnE procedure can be repeated any number of times.

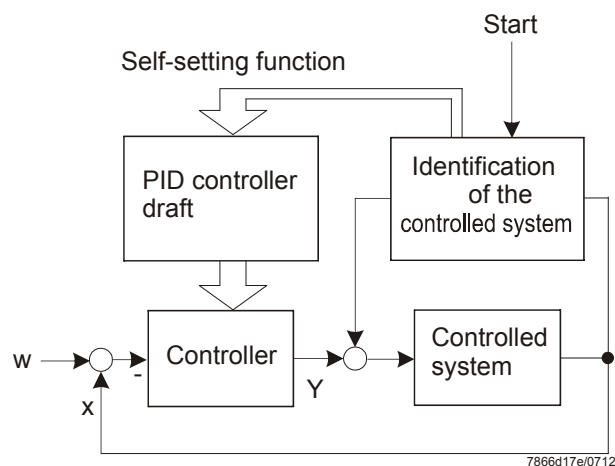

Figure 24: Self-setting function in high-fire operation



## 2 procedures

The **tUnE** function uses 2 different methods that are automatically selected depending on the dynamic state of the actual value and the deviation from the setpoint at startup. **tUnE** can be started from within any dynamic actual value sequence.

If there is a **great difference between actual value and setpoint** when **tUnE** is activated, a switching line is established about which the controlled variable performs forced oscillations during the self-setting process. The switching line is set to such a level that the actual value should not exceed the setpoint.

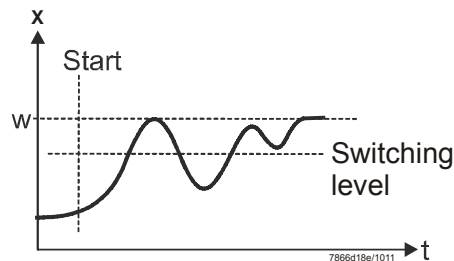

Figure 25: Great difference between actual value and setpoint

With a **small deviation** between setpoint and actual value (after the controlled system has settled, for instance), forced oscillation about the setpoint is performed.

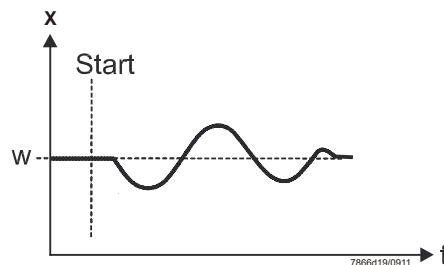

Figure 26: Small control deviation

The data of the controlled system recorded for the forced oscillations are used to calculate the controller parameters **rt**, **dt**, **Pb1** and a filter time constant **dF1** for actual value filtering that is optimized for this controlled system.

## Conditions

- High-fire operation in *modulating burner* mode
- The thermostat function (relay K1) must be constantly activated; otherwise **tUnE** will be canceled and no optimized controller parameters will be adopted
- The above mentioned actual value oscillations during the self-setting process must not exceed the upper threshold of the thermostat function (increase if necessary, and lower the setpoint)



### Note!

A successfully started *Self-setting* function is automatically aborted after 2 hours. This could occur in the case of a controlled system that responds slowly, for example, where, even after 2 hours, the described procedures cannot be successfully completed.

## 9.2 Checking the controller parameters

Optimum adjustment of the controller to the controlled system can be checked by recording a startup sequence with the control loop closed. The following diagrams indicate possible incorrect adjustments, and their correction.

### Example

The response to a setpoint change is shown here for a 3rd order controlled system for a PID controller. The method used for adjusting the controller parameters can, however, also be applied to other controlled systems. A suitable value for  $dt$  is  $rt/4$ .

**Pb too small**

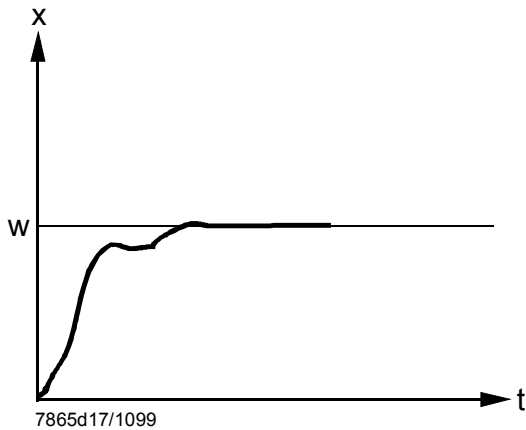

7865d17/1099  
Figure 27: Pb too small

**Pb too large**

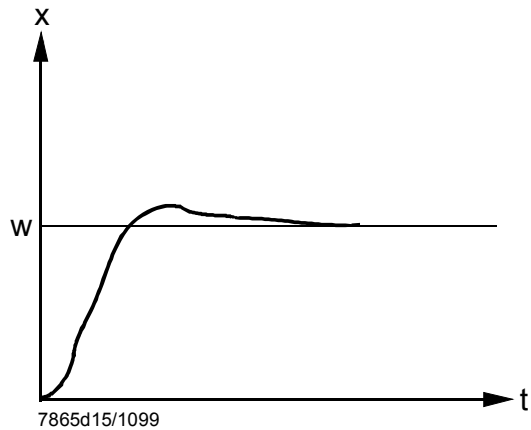

7865d15/1099  
Figure 28: Pb too large

**rt, dt too small**

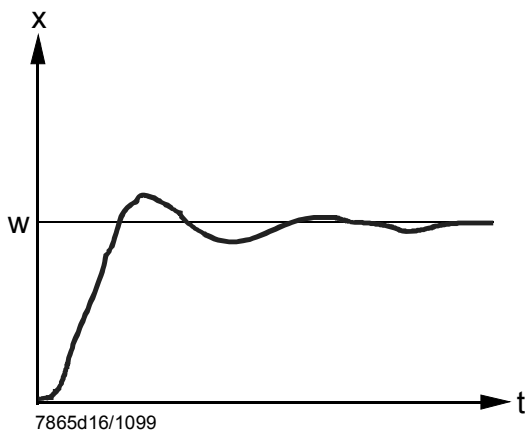

7865d16/1099  
Figure 29: rt, dt too small

**rt, dt too large**

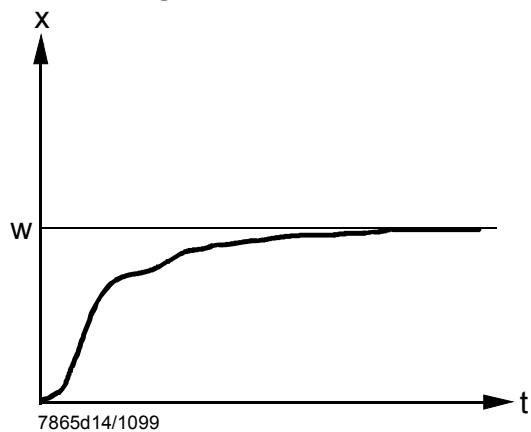

7865d14/1099  
Figure 30: rt, dt too large

**Optimum adjustment**

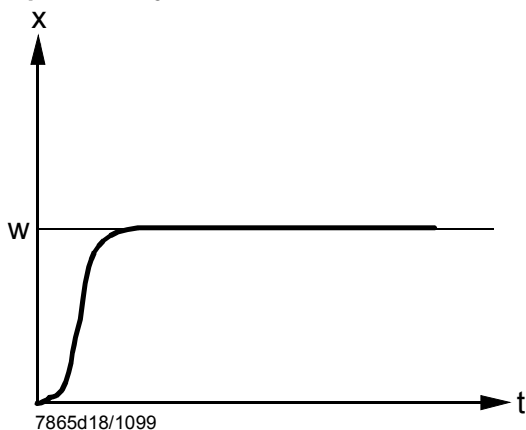

7865d18/1099  
Figure 31: Optimum adjustment

# 10 PC software ACS411

---

PC software ACS411 is an operating module for use with the RWF50... universal controller and designed for the following basic tasks:

- Visualization of system state covering the following data:
  - Parameters
  - Process data
  - Configuration and parameterization of the controller (individual parameters)
  - Saving and restoration of parameter sets

A USB cable can be used to establish the connection between PC (USB plug type A, 4 pins) and RWF50... (USB plug type Mini B, 5 pins).



**Note!**  
The cable must be purchased on site.

## 10.1 Safety notes



**Caution!**  
PC software ACS411 is a convenient tool for use by qualified personnel, designed to commission and optimize the universal controller. Since the required actions and settings are safety-related, the user has a special obligation to exercise due care. Although specific technical measures have been taken to prevent incorrect entry of data and wrong parameter values, the user must check the correct function of the plant in a conventional way both during and after commissioning and – if required – ensure manual shutdown.

## 10.2 Setting the correct system parameters



**Caution!**  
It should be noted that the characteristics of the universal controller are determined primarily by the parameter settings made, rather than by the type of unit. It is especially the OEM which is responsible for making certain that the controller's parameter settings are in compliance with the standards covering the respective application or type of plant. Responsibility for the parameter settings is assumed by the person who, in accordance with the access rights, makes or has made changes at the respective setting level. The detailed descriptions and safety notes given in the User Manual on the system components must also be observed.

## 10.3 Changing the parameters



**Caution!**  
After changing parameters, all parameters must be checked via the unit's display to ensure they are correctly set – without making use of the PC software ACS411.

## 10.4 Place of installation



### Caution!

PC software ACS411 is designed for use on site, that is, within viewing and hearing distance of the respective combustion plant. This means that remote control is not permitted.

## 10.5 License and liability regulations



### Note!

For ENDUSER LICENSE AGREEMENT for PC software ACS411, refer to program menu item *Info* → *Software documentation*.

**IMPORTANT – PLEASE READ CAREFULLY!**

## 10.6 Procurement of PC software ACS411

For ordering the ACS411 software and updates, please contact your supplier or heating engineer.

## 10.7 Languages

PC software ACS411 is available in English and German. To select the language you require, go to program menu item *File* → *Default settings* → *Program language* (ACS411 setup program must be restarted).

## 10.8 Operating systems : Operating

- Windows 2000 SP4
- Windows 7 - 32 bit
- Windows 7 - 64 bit
- Windows VISTA
- Windows XP

## 10.9 Prerequisites for hardware

- Free hard disk memory: 300 MB
- RAM: 512 MB

## 10.10 Installation



### Note!

First, install PC software ACS411; then, connect the controller. If not observed, an error message is delivered.

PC software ACS411 is supplied on a CD.

- \* Insert CD in the CD or DVD drive.  
Setup starts automatically.
- \* Follow the instructions appearing on the screen.
- \* Connect PC and controller via the USB cable.  
New hardware is identified and USB driver installed.  
This may take a few minutes.
- \* Follow further instructions given on the screen and wait until the installation is successfully completed.

## 10.11 Others

### 10.11.1 Use of USB port : Use of

#### Use

The USB port is intended for temporary use to make the parameter settings, the configuration and for work in connection with commissioning.  
When using the USB port, the controller can be securely operated, tested and set with no need for using the mains cable.

### 10.11.2 Powering the controller via the USB port : Powering the controller

via the port

**Using the HUB:** Using the

If the controller shall be powered via the USB port, a HUB with power supply is required, capable of delivering at least 500 mA at every outlet.

**Switching off:** Switching off

When supplying power via the USB port, relays and analog output are deenergized to reduce power consumption.



### Note!

Check to ensure that power supply to the measuring converter (G+ and G-) is not connected. This increases power usage via the USB port as well.

**Measuring accuracy:**

The measuring accuracy specified in chapter 12 *Technical data* does not apply when powering the controller via the USB port.

# 11 What to do if ...

## 11.1 Alarm messages:

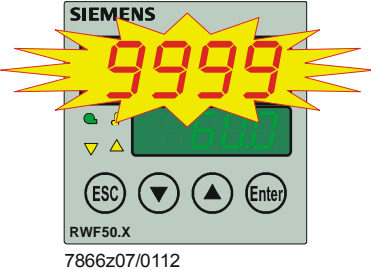
Display	Cause	Remedy
<p>9999 flashing</p>  <p>RWF50.X 7866z07/0112</p>	<p><b>Measured value exceeded limit</b> The measured value is too great, lies outside the measuring range, or the sensor is faulty</p> <p>-----</p> <p><b>Measured value dropped below limit</b> The measured value is too small, lies outside the measuring range, or the sensor has a short-circuit</p>	<p>* Check to see if sensor and connecting line are damaged or have a short-circuit</p> <p>⇒ Reference! See chapter 4.3 <i>Assignment of pins</i></p> <p>* Check to see if the correct sensor is selected or connected</p> <p>⇒ Reference! See chapter 8.1 <i>Analog input I nP1</i></p>

## 11.2 Others

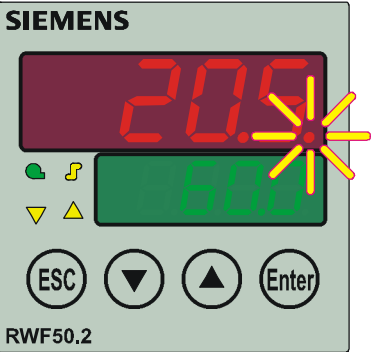
Display	Cause	Remedy
<p>On the upper display, the decimal place to the right is lit</p>  <p>RWF50.2 7866z08/0911</p>	<p>USB connection</p>	<p>Remove USB connection</p> <p>⇒ Reference! See chapter 10 <i>PC software ACS411</i></p>

## 12 Technical data

### 12.1 Inputs

#### 12.1.1 Resistance thermometers

Type	Measuring range	Measuring accuracy <sup>a</sup>	Impact of ambient temperature
Pt100; DIN EN 60751	-200...850 °C (-328...1562 °F)	≤0.1%	50 ppm/K
Pt1000; DIN EN 60751	-200...850 °C (-328...1562 °F)	≤0.1%	50 ppm/K
LG-Ni1000	-50...+160 °C (-58...320 °F)	≤0.1%	50 ppm/K
0...135 Ω		≤0.25%	50 ppm/K

<sup>a</sup> Accuracies relate to the maximum measuring range.

Line resistance	Max. 30 Ω per line with 3-wire circuit
Line balancing	Not required with 3-wire circuits. With 2-wire circuits, line balancing can be performed by making an actual value correction

#### 12.1.2 Input signals

Measuring range	Measuring accuracy <sup>a</sup>	Impact of ambient temperature
Voltage DC 0...10 V Input resistance RE >2 MΩ	≤0.1%	100 ppm/K
Voltage DC 0(1)...5 V Input resistance RE >2 MΩ	≤0.2%	200 ppm/K
Current 0(4)...20 mA Voltage drop ≤2 V	≤0.1%	100 ppm/K

<sup>a</sup> Accuracies relate to the maximum measuring range.

#### 12.1.3 Binary input D1

Potentialfree contact for the following functions, depending on the configuration:

- No function
- Setpoint readjustment
- Setpoint changeover
- Operating mode changeover

## 12.2 Monitoring the measuring circuit

In the event of error, the outputs assume defined states (configurable).

Measuring transducer	Measured value crossed limit	Sensor/line has short-circuit	Sensor/line interrupted
Resistance thermometer	●	●	●
Voltage 1...5 V 0...5 V, 0...10 V	● (●)	● ---	● ---
Current 4...20 mA 0...20 mA	● (●)	● ---	● ---

● = detected

(●) = detected only if measuring range is exceeded

- = not detected

## 12.3 Controller outputs OutP Controller o

<b>Relay K1 (NO) 1P, 1N</b> (burner release)	
Contact rating	Max. 1 A at AC 250 V at $\cos\phi > 0.6$
Contact life	100,000 switching cycles at high-fire
Contact protection	Varistor
<b>Power supply for transducer G+, G-</b>	DC 24 V $\pm 10\%$ /max. 25 mA short-circuit-proof

The following relay data are those specified by the supplier.

### Only RWF50.2

<b>Relay K2, KQ</b> (controlling element OPEN)	
Contact rating	Max. 1 A at AC 250 V and $\cos\phi > 0.6$
Contact life	100,000 switching cycles at high-fire
Contact protection	RC combination
<b>Relay K3, KQ</b> (controlling element CLOSE)	
Contact rating	Max. 1 A at AC 250 V at $\cos\phi > 0.6$
Contact life	100,000 switching cycles at high-fire
Contact protection	RC unit

Relay data are those specified by the supplier.

### Only RWF50.3

<b>Analog output A+, A-</b>	
Voltage	DC 0...10 V short-circuit-proof
Load resistance	$R_{Last} \geq 500 \Omega$
Accuracy	$\leq 0.25\%$ , $\pm 50$ ppm/K
Current	0...20 mA/4...20 mA
Load resistance	$R_{Last} \leq 500 \Omega$
Accuracy	$\leq 0.25\%$ , $\pm 50$ ppm/K

## 12.4 Controller

Type of controller	
- RWF50.2	Modulating controller
- RWF50.3	Continuous controller
Controller structure	P/PI/PD/PID
Sampling time	250 ms



## 12.5 Electrical data

Power supply (switching network section)	AC 110...240 V +10/-15% 48...63 Hz
Electrical safety	To DIN EN 60730, part 1 Overvoltage category II Degree of contamination 2
Power consumption	Max. 16 VA
Data backup	EEPROM
Electrical connection	At the rear via screw terminals
- Cross-sectional area	0.25...1.5 mm <sup>2</sup> fine-wired
- Stranded wire with	- Ferrules to DIN 46228 - Pin-type cable socket to DIN 46231 - Crimp-type cable socket in fork-form for M3 thread (dimensions to DIN 46237)
With UL applications	Use of the cable lug or ferrules to UL486A-B (UL listed or recognized)
Tightening torque	0.5 Nm
Electromagnetic compatibility	DIN EN 61326-1
Emitted interference	Class B
Immunity	Meeting industrial requirements

## 12.6 Housing

Type of housing	Made of Makrolon for control panel mounting to DIN IEC 61554 (use in indoor)
Color	Light-grey RAL7035
Mounting depth	92 mm
Mounting position	Optional
Degree of protection	To DIN EN 60529 Front side IP66 Rear IP20
Weight	(Fully equipped)
- RWF50.2	Approx. 170 g
- RWF50.3	Approx. 168 g

## 12.7 Environmental conditions

<b>Storage</b>	DIN IEC 60721-3-1
Climatic conditions	Class 1K3
Mechanical conditions	Class 1M2
Temperature range	-40...70 °C
Humidity	<95% r.h.
<b>Transport</b>	DIN IEC 60721-3-2
Climatic conditions	Class 2K2
Mechanical conditions	Class 2M2
Temperature range	-40...70 °C
Humidity	<95% r.h.
<b>Operation</b>	DIN IEC 60721-3-3
Climatic conditions	Class 3K3
Mechanical conditions	Class 3M3
Temperature range	-20...50 °C
Humidity	<95% r.h.
Installation altitude	Max. 2,000 m above sea level



### Attention!

Condensation, formation of ice and ingress of water are not permitted!

## 12.8 Segment display

Height of numerals	
- Upper display	10 mm
- Lower display	7 mm
Color	
- Upper display	Red
- Lower display	Green
Digits	4 (including 0, 1 or 2 decimal places, configurable)
Range of display	-1999...9999

## 12.9 Standards and certificates



Conformity to EEC directives

- Electromagnetic compatibility EMC (immunity)

2004/108/EC

- Low-voltage directive, to DIN EN 60730-1

2006/95/EC



ISO 9001: 2008  
Cert. 00739



ISO 14001: 2004  
Cert. 38233



# 13 Key

---

A	Switch-on point for high-fire when response threshold (q) is reached
B	Switch-off point for burner
bi n1	Binary input 1
bi nF	Binary input
CAct	Operating action
Cntr	Controller
CodE	Level lockout
ConF	Configuration
CtYP	Controller type
db	Dead band
dECP	Decimal point
dF1	Filter time constant
di SL	Lower display
di SP	Display
di SU	Upper display
dSP	Setpoint
dt	Derivative action time
End	End value
FnCt	Function
HYS1	Switch-on threshold heating controller
HYS2	Switch-off threshold heating controller
HYS3	Switch-off threshold heating controller
HYS4	Switch-on threshold cooling controller
HYS5	Switch-off threshold cooling controller
HYS6	Switch-off threshold cooling controller
I nP	Analog input
I nP1	Analog input 1
OFF1	Correction of measured value
oLHi	Upper working range limit
oLLo	Lower working range limit
OPnt	Zero point
OPr	User
OutP	Control outputs
PArA	Parameter
Pb	Proportional range
Pb1	Proportional range 1
q	Response threshold
qeff	Sum of all integrals
rAFC	Thermal shock protection
rAL	Limit value
rASL	Ramp slope
rOut	Value when out of range
rt	Integral action time
SCH1	End of display
SCL1	Start of display
SEn1	Sensor type
Si Gn	Signal type
SP1	Setpoint 1
SP2	Setpoint 2
SPH	Setpoint limitation end
SPL	Setpoint limitation start
t	Time
t1	Power ON (startup at actual value)
t2	Actual value of ramp stop outside tolerance band
t3	Actual value returned to tolerance band

t4	Setpoint reached, thermal shock protection (TSS) no longer active
tolP	Tolerance band of ramp
tout	Timeout
tt	Running time of controlling element
Unit	Unit of temperature
W	Setpoint
Y	Angular positioning

# 14 List of figures

---

Figure 1: Block structure.....	12
Figure 2: Dimensions of RWF50.....	14
Figure 3: Mounting in a panel cutout .....	15
Figure 4: Test voltages .....	18
Figure 5: Assignment of terminals .....	19
Figure 6: Control sequence of heating controller.....	21
Figure 7: Control sequence of cooling controller .....	21
Figure 8: Control sequence of modulating burner, 3-position output.....	22
Figure 9: Control sequence of modulating burner, analog output .....	23
Figure 10: Control sequence of 2-stage burner, 3-position output .....	24
Figure 11: Control sequence of 2-stage burner, analog output .....	25
Figure 12: Setpoint changeover or setpoint shift .....	27
Figure 13: Control sequence response threshold (q) .....	28
Figure 14: Control sequence <i>Cold start of plant</i> .....	29
Figure 15: Thermal shock protection (TSS).....	31
Figure 16: Meaning of display and buttons.....	32
Figure 17: Display start.....	33
Figure 18: Basic display .....	33
Figure 19: Display of self-setting function.....	37
Figure 20: Display of software version .....	38
Figure 21: Display segment test .....	38
Figure 22: Parameterization .....	39
Figure 23: Configuration .....	41
Figure 24: Self-setting function in high-fire operation .....	48
Figure 25: Great difference between actual value and setpoint .....	49
Figure 26: Small control deviation .....	49
Figure 27: Pb too small.....	50
Figure 28: Pb too large .....	50
Figure 29: rt, dt too small .....	50
Figure 30: rt, dt too large.....	50
Figure 31: Optimum adjustment .....	50

# Index

<b>A</b>	
<b>ACS411</b>	
Changing the parameters .....	51
Installation .....	53
Languages .....	52
License and liability regulations .....	52
Others .....	53
PC software ACS411 .....	51
Place of installation .....	52
Prerequisites for hardware .....	52
Procurement of PC software ACS411 .....	52
Safety notes .....	51
Setting the correct system parameters .....	51
<b>C</b>	
<b>Configuration</b>	
Analog input I nP1 .....	42
Analog output .....	45
Binary functions bi nF .....	46
Binary output .....	45
Control outputs OutP .....	45
Controller Cntr .....	43
Display di SP .....	47
Thermal shock protection (TSS) rAFC .....	44
Configuration ConF .....	41
<b>E</b>	
<b>Electrical connection</b>	
Connection of external components .....	17
<b>Electrical connections</b> .....	17
Assignment of terminals .....	19
Fusing .....	17
Galvanic separation .....	18
Incorrect use .....	17
Installation notes .....	17
Safety regulations .....	17
Screw terminals .....	17
Suppression of interference .....	17
<b>I</b>	
<b>Identification of product no.</b> .....	13
Location .....	13
Product nos. ....	13
Scope of delivery .....	13
Type field .....	13
<b>Installation</b> .....	14
Cleaning the front .....	16
Dimensions .....	14
Installation site and climatic conditions .....	14
Mounting the controller in a panel cutout .....	15
Removing the controller from the panel cutout .....	16
Side-by-side mounting .....	15
<b>Introduction</b> .....	8
Block structure .....	12
Control .....	11
Cooling controller .....	11
Correct use .....	9
Description .....	11
General notes .....	8
Mounting .....	11
Notification symbols .....	10
Presentation .....	10
Qualified personnel .....	9
Safety notes .....	9
Typographical conventions .....	9
Use in heating plants .....	11
Warning symbols .....	9
<b>K</b>	
<b>Key</b> .....	59
<b>O</b>	
<b>Operating modes</b> .....	21
2-stage burner, 3-position output .....	24
2-stage burner, analog output .....	25
Burner shutdown .....	26
Cold start of plant .....	29
Cooling controller .....	21, 23, 25, 28, 30
Entry .....	27
Heating controller .....	21, 29
High-fire operation .....	22
Interlocking .....	29, 31
Low-fire operation .....	21
Modulating burner, 3-position output .....	22
Modulating burner, analog output .....	23
Operating mode changeover .....	22
Predefined setpoint .....	27
Response threshold (q) .....	28
Setpoint changeover or setpoint shift .....	27
Thermal shock protection .....	31
Thermostat function .....	21
<b>Operation</b> .....	32
3-position controller .....	35
Basic display .....	33
Basic display .....	32
Cancel .....	37
Changing the setpoints .....	34
Display of software version .....	38
Flashing actual value display .....	32
Initialization .....	32
Manual control .....	32
Manual control, 2-stage burner .....	36
Manual control, modulating burner .....	35
Meaning of display and buttons .....	32
Modulating controller .....	35
Parameter display .....	32
Segment test .....	38
Self-setting function .....	32
Start .....	37
Starting the self-setting function .....	37

Timeout.....	34	<b>Self-setting function in high-fire operation .....</b>	<b>48</b>
<b>User level.....</b>	<b>34</b>	<b>T</b>	
<b>P</b>		<b>Technical data .....</b>	<b>55</b>
Parameterization		<b>Binary input D1 .....</b>	<b>55</b>
Display of controller parameters.....	40	<b>Controller.....</b>	<b>56</b>
<b>Parameterization PARa.....</b>	<b>39</b>	<b>Controller outputs OutP .....</b>	<b>56</b>
<b>PC software ACS411</b>		<b>Electrical data .....</b>	<b>57</b>
<b>Measuring accuracy .....</b>	<b>53</b>	<b>Environmental conditions.....</b>	<b>58</b>
<b>Operating systems .....</b>	<b>52</b>	<b>Housing .....</b>	<b>57</b>
<b>Powering the controller via the USB port .....</b>	<b>53</b>	<b>Input signals.....</b>	<b>55</b>
<b>Use of USB port .....</b>	<b>53</b>	<b>Inputs .....</b>	<b>55</b>
<b>Using the HUB .....</b>	<b>53</b>	<b>Monitoring the measuring circuit.....</b>	<b>56</b>
<b>PC-Software ACS411</b>		<b>Resistance thermometers .....</b>	<b>55</b>
<b>Switching off .....</b>	<b>53</b>	<b>Segment display .....</b>	<b>58</b>
<b>S</b>		<b>Standards and certificates.....</b>	<b>58</b>
<b>Self-setting function .....</b>	<b>48</b>	<b>W</b>	
<b>2 procedures .....</b>	<b>49</b>	<b>What to do if... .....</b>	<b>54</b>
<b>Checking the controller parameters .....</b>	<b>50</b>	<b>Alarm messages .....</b>	<b>54</b>
<b>Conditions .....</b>	<b>49</b>	<b>Others .....</b>	<b>54</b>

Siemens AG Infrastructure & Cities Sector Building Technologies Division  
Berliner Ring 23  
D-76437 Rastatt  
Tel. +49 7222 598 279  
Fax +49 7222 598 269  
www.siemens.com

© 2014 Siemens AG Infrastructure & Cities Sector  
Building Technologies Division  
Subject to change!